

# DATASENSOR

## SG4-B SERIES

*base*

Safety light curtains with infrared beams



# INSTRUCTION MANUAL

---

DATASENSOR S.p.A. Via Lavino 265  
40050 Monte S. Pietro - Bologna - Italy  
Tel: +39 051 6765611 Fax: +39 051 6759324  
<http://www.datasensor.com> e-mail: [info@datasensor.com](mailto:info@datasensor.com)

DATASENSOR S.p.A. reserves the right to make modifications and improvements without prior notification.

**826003871 Rev.B**  
*Copyright © 2008-2009 Datasensor*

We

**DATASENSOR S.p.A.**  
Via Lavino, 265  
40050 Monte San Pietro  
Bologna - Italy

Declare, under the terms of EC Machine Directive 98/37/EEC, Appendix II C, that the product(s)

**SG4-xx-xxx-00-x**

**SAFETY LIGHT CURTAINS -  
ELECTRO-SENSITIVE PROTECTIVE EQUIPMENT (TYPE 2)  
AND ALL ITS MODELS**

are safety components for a machine constructed as per the EC Directive 98/37/EEC. This declaration will lose its validity if any modification to devices is applied without prior consultation.

We employ a quality system certified by the CSQ, Nr. 9115.IES2, as per ISO 9001 and have therefore observed the regulations foreseen during development and production, as well as the following EC directives and EN standards:

**EC directives:**

**98/37/EEC:** EC MACHINE DIRECTIVE [42/2006/EC AFTER 30 DEC 2009]

**89/336/EEC:** EMC DIRECTIVE [108/2004/EC AFTER 20 JUL 2009]

**2006/95/EEC:** LOW-VOLTAGE DIRECTIVE

**Standards:**

**EN 55022, 2006:** LIMITS AND METHODS OF MEASUREMENTS OF RADIO DISTURBANCE OF INFORMATION TECHNOLOGY EQUIPMENT

**EN 61000-4-2, 1995 + A1:1998 + A2:2001:** ELECTROMAGNETIC COMPATIBILITY (EMC). PART 4: TESTING AND MEASUREMENT TECHNIQUES. SECTION 2: ELECTROSTATIC DISCHARGE IMMUNITY TEST

**EN 61000-4-3, MAY 2006:** ELECTROMAGNETIC COMPATIBILITY (EMC). PART 4: TESTING AND MEASUREMENT TECHNIQUES. SECTION 3: RADIATED, RADIO-FREQUENCY, ELECTROMAGNETIC FIELD IMMUNITY TEST

**EN 61000-4-4, DECEMBER 2004:** ELECTROMAGNETIC COMPATIBILITY (EMC). PART 4: TESTING AND MEASUREMENT TECHNIQUES. SECTION 4: ELECTRICAL FAST TRANSIENT/BURST IMMUNITY TEST

**EN 61000-4-5, NOVEMBER 2006:** ELECTROMAGNETIC COMPATIBILITY (EMC). PART 4: TESTING AND MEASUREMENT TECHNIQUES. SECTION 5: SURGE IMMUNITY TEST

**EN 61000-4-6, 1996 + A1:2001:** ELECTROMAGNETIC COMPATIBILITY (EMC). PART 4: TESTING AND MEASUREMENT TECHNIQUES. SECTION 6: IMMUNITY TO CONDUCTED DISTURBANCES, INDUCED BY RADIO-FREQUENCY FIELDS

**EN 61508-3, DECEMBER 2001:** FUNCTIONAL SAFETY OF ELECTRICAL/ELECTRONIC/PROGRAMMABLE ELECTRONIC SAFETY-RELATED SYSTEMS. PART 3: SOFTWARE REQUIREMENTS

**EN 61496-1, MAY 2004:** SAFETY OF MACHINERY - ELECTRO-SENSITIVE PROTECTIVE EQUIPMENT. PART 1: GENERAL REQUIREMENTS AN TESTS

**CLC/TS 61496-2, JULY 2006:** SAFETY OF MACHINERY - ELECTRO-SENSITIVE PROTECTIVE EQUIPMENT. PART 2: PARTICULAR REQUIREMENTS FOR EQUIPMENT USING ACTIVE OPTO-ELECTRONIC PROTECTIVE DEVICES (AOPDs)

Conformity has been certified by the following Competent Body (identification n°0123):  
TÜV Product Service GMBH, Zertifizierstelle – Ridlerstrasse, 65 – D80339 München

Monte San Pietro, 18/11/2008

Giuseppe De Maria

*Giuseppe De Maria*

Quality Assurance



## INDICE

<b>1. GENERAL INFORMATION .....</b>	<b>1</b>
1.1. General Description of the safety light curtains.....	1
1.1.1. <i>Package contents</i> .....	3
1.2. New features compared to SE4-Plus series (with EDM function) .....	3
1.3. How to choose the device .....	4
1.3.1. <i>Resolution</i> .....	4
1.3.2. <i>Controlled height</i> .....	5
1.3.3. <i>Minimum installation distance</i> .....	6
1.4. Typical applications .....	8
1.5. Safety information .....	11
<b>2. INSTALLATION MODE .....</b>	<b>12</b>
2.1. Precautions to be observed for the choice and installation .....	12
2.2. General information on device positioning .....	13
2.2.1. <i>Minimum installation distance</i> .....	14
2.2.2. <i>Minimum distance from reflecting surfaces</i> .....	15
2.2.3. <i>Distance between homologous devices</i> .....	17
2.2.4. <i>Emitter and receiver orientation</i> .....	20
2.2.5. <i>Use of deviating mirrors</i> .....	20
2.2.6. <i>Controls after first installation</i> .....	21
<b>3. MECHANICAL MOUNTING .....</b>	<b>23</b>
<b>4. ELECTRICAL CONNECTIONS .....</b>	<b>26</b>
4.1. Notes on connections.....	28
4.2. Ground connection .....	31
<b>5. ALIGNMENT PROCEDURE .....</b>	<b>33</b>
5.1. Correct alignment procedure.....	34
<b>6. FUNCTIONING MODE .....</b>	<b>36</b>
6.1. Restart mode.....	36
6.2. Test function.....	37
6.3. Reset function .....	37
6.4. EDM function.....	38
6.5. Alignment aid function.....	39
<b>7. DIAGNOSTIC FUNCTIONS .....</b>	<b>40</b>
7.1. User interface.....	40
7.2. Diagnostic messages.....	41
<b>8. PERIODICAL CHECKS .....</b>	<b>44</b>
8.1. General informatio and useful data .....	45
8.2. Warranty.....	46
<b>9. DEVICE MAINTENANCE .....</b>	<b>47</b>
9.1. Product disposal.....	47
<b>10. TECHNICAL DATA .....</b>	<b>48</b>
<b>11. LIST OF AVAILABLE MODELS .....</b>	<b>49</b>
<b>12. OVERALL DIMENSIONS .....</b>	<b>50</b>
<b>13. OUTFIT .....</b>	<b>51</b>
13.1 Angled fixing bracket mounting .....	52
<b>14. ACCESSORIES.....</b>	<b>53</b>
<b>15. GLOSSARY.....</b>	<b>59</b>

## 1. GENERAL INFORMATION

### 1.1. General Description of the safety light curtains

The safety light curtains of the SG4 series are optoelectronic multibeam devices that are used to protect working areas that, in presence of machines, robots, and automatic systems in general, can become dangerous for operators that can get in touch, even accidentally, with moving parts.

The light curtains of the SG4 series are Type 4 intrinsic safety systems used as accident-prevention protection devices and are manufactured in accordance with the international Standards in force for safety, in particular:

**CEI IEC 61496-1: 2004** Safety of machinery: electrosensitive protective equipment. Part 1: General prescriptions and tests.

**CEI IEC 61496-2: 2006** Safety of machinery: electrosensitive protective equipment - Particular requirements for equipment using active optoelectronic protective devices.

The device, consisting of one emitter and one receiver housed inside strong aluminium profiles, generates infrared beams that detect any opaque object positioned within the light curtain detection field.

The emitter and the receiver are equipped with the command and control functions. The connections are made through a M12 connector located in the lower side of the profile.

The synchronisation between the emitter and the receiver takes place optically, *i.e.* no electrical connection between the two units is required.

The microprocessor guarantees the check and the management of the beams that are sent and received through the units: The microprocessor LEDs inform the operator about the general conditions of the safety light curtain (see section 7 “*Diagnostic functions*”).

The device consists in 2 units that, according to the model, are composed by one or several emitting and receiving modules. The receiver checks the control operations and safety actions.

During installation, an user interface facilitates the alignment of both units (see section 5 "*Alignment procedure*").

As soon as an object, a limb or the operator's body accidentally interrupts one or some of the infrared beams sent by the emitter, the receiver immediately opens the OSSD outputs and blocks the MPCE machine (if correctly connected to the OSSD).

Some parts or sections of this manual containing important information for the user or installing operator are preceded by a note:

 Notes and detailed descriptions about particular characteristics of the safety devices in order to better explain their functioning.  
Special instructions regarding the installation process.

 The information provided in the paragraphs following this symbol is very important for safety and may prevent accidents.  
Always read this information accurately and carefully follow the advice to the letter.

This manual contains all the information necessary for the selection and operation of the safety devices.

However, specialised knowledge not included in this technical description is required for the planning and implementation of a safety light curtain on a power-driven machine. As the required knowledge may not be completely included in this manual, we suggest the customer to contact DATASENSOR S.p.A. Technical Service for any necessary information relative to the functioning of the SG4 light curtains and the safety rules that regulate the correct installation (see section 8 "*Periodical checks*").

### 1.1.1. Package contents

- Package contains the following objects:
- Receiver (RX)
- Emitter (TX)
- Installation Quick Guide of SG4-B curtain
- Biannual checklist and periodical maintenance schedule
- CD with instruction manual and other documents
- 4 angled fixing brackets and specific fasteners
- 2 angled fixing brackets for models with heights included between 1200 and 1800 mm

### 1.2. New features compared to SE4-Plus series (with EDM function)

With respect to SE4-Plus (EDM) series, the SG4-B safety light curtain series presents new important features:

- Higher operating distance
- Shorter response time (see sect.10 “Technical Data”)
- Range enlargement with 150 to 1800 mm controlled heights
- New profile compatible with SE accessories
- New fastening system with rotating brackets
- TEST line with reversed activation logics (active high)
- Advanced alignment for receiver and transmitter units

Furthermore, SG4-B has 2 selectable functions, i.e.:

- EDM function
- Manual/automatic Restart

### 1.3. How to choose the device

There are at least three different main characteristics that should be considered when choosing a safety light curtain, after having evaluated the risk assessment:

#### 1.3.1. Resolution

The resolution of the device is the minimum dimension that an opaque object must have in order to obscure at least one of the beams that constitute the sensitive area.

The resolution strictly depends on the part of the body to be protected.

$R = 14\text{mm}$       Finger protection



$R = 30\text{ mm}$       Hand protection



As shown in Fig.1, the resolution only depends on the geometrical characteristics of the lenses, diameter and distance between centres, and is independent of any environmental and operating conditions of the safety light curtain.

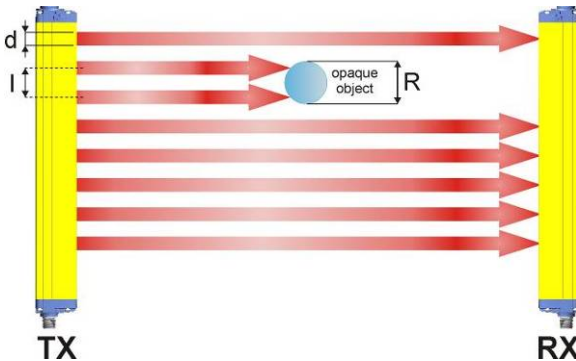

Fig. 1

The resolution value is obtained applying the following formula:

$$R = l + d$$

where:

$l$  = Distance between two adjacent optics

$d$  = Lens diameter

1.3.2. *Controlled height*

The controlled height is the height protected by the safety light curtain (Hp)

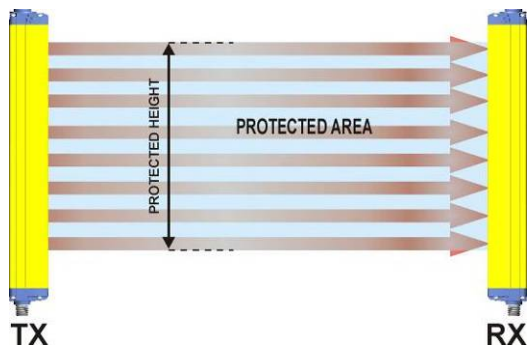

Fig. 2

The SG4-B controlled height is delimited by the yellow line pad-printed on the front glass and by the dimensions listed in the table:

	Model	Controlled height Hp (mm)
<p>The diagram shows two vertical units. A vertical double-headed arrow between a red dotted line at the top and a red solid line at the bottom is labeled 'Hp'. The red solid line is labeled 'Reference'.</p>	SG4-xx-015-00-E	150
	SG4-xx-030-00-E	300
	SG4-xx-045-00-E	450
	SG4-xx-060-00-E	600
	SG4-xx-075-00-E	750
	SG4-xx-090-00-E	900
	SG4-xx-105-00-E	1050
	SG4-xx-120-00-E	1200
	SG4-xx-135-00-E	1350
	SG4-xx-150-00-E	1500
	SG4-xx-165-00-E	1650
	SG4-xx-180-00-E	1800

xx = Resolution (14 mm – 30 mm)

### 1.3.3. Minimum installation distance

The safety device must be positioned at a specific safety distance (Fig. 3). This distance must ensure that the dangerous area cannot be reached before the dangerous motion of the machine has been stopped by the ESPE.

The safety distance depends on 4 factors, according to the **EN-999** Standard:

- Response time of the ESPE (the time between the effective beam interruption and the opening of the OSSD contacts).
- Machine stopping time (the time between the effective opening of the contacts of the ESPE and the real stop of the dangerous motion of the machine).
- ESPE resolution.
- Approaching speed of the object to be detected.

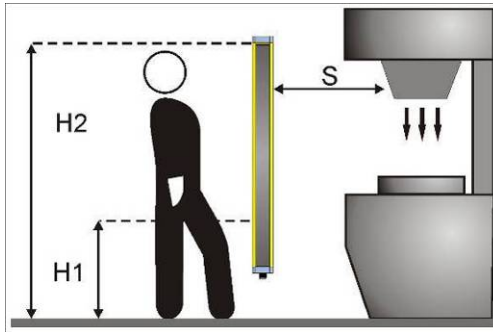

Fig. 3

The following formula is used for the calculation of the safety distance:

$$S = K (t_1 + t_2) + C$$

where:

$S$  = Minimum safety distance in mm.

$K$  = Speed of the object, limb or body approaching the dangerous area in mm/sec.

$t_1$  = Response time of the ESPE in seconds (see section 10 "Technical data")

$t_2$  = Machine stopping time in seconds.

$d$  = Resolution of the system.

$C$  = Additional distance based on the possibility to insert the body or one of body parts inside the dangerous area before the protective device trips.

$C$  =  $8 (d - 14)$  for devices with resolution  $\leq 40$  mm.

 **NOTE:** K value is:

**2000 mm/s if the calculated value of S is  $\leq 500$  mm**

**1600 mm/s if the calculated value of S is  $> 500$  mm**

When devices with  $> 40$  mm resolution are used, the height of the top beam has to be  $\geq 900$  mm (H2) from machine supporting base while the height of the bottom beam has to be  $\leq 300$  mm (H1).

If the safety light curtain must be mounted in a horizontal position (Fig.4), the distance between the dangerous area and the most distant optical beam must be equal to the value calculated using the following formula:

$$S = 1600 \text{ mm/s } (t_1 + t_2) + 1200 - 0.4 H$$

where:

S = Minimum safety distance in mm.

$t_1$  = Response time of the ESPE in seconds  
(see section 10 "Technical data")

$t_2$  = Machine stopping time in seconds.

H = Beam height from ground. This height must always be less than 1,000 mm.

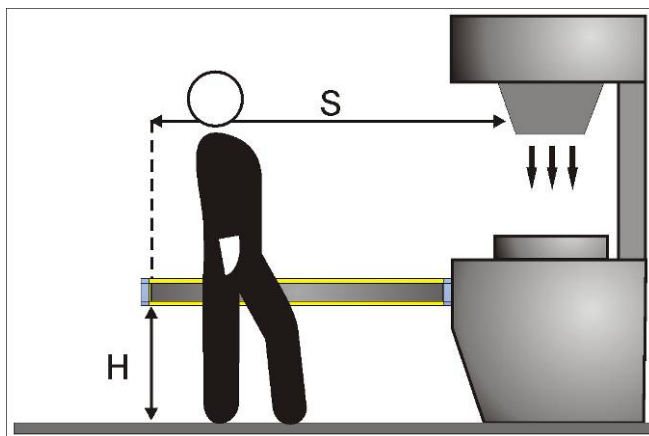

**Fig. 4**

## Practical examples

Let's suppose to have a light curtain with height = 600 mm  
To calculate the distance of the device from the ESPE, in a vertical position, the following formula is used:

$$S = K \cdot T + C$$

where:

$$T = t_1 + t_2$$

$t_1$  = ESPE response time + SE-SR2 relay release time (max 80 ms)

$t_2$  = Machine total stopping time.

C =  $8 \cdot (d - 14)$  for devices with resolution  $\leq 40$  mm

D = resolution

In all cases, if  $K = 2000\text{mm/sec}$  then  $S > 500$  mm. Distance will have then to be recalculated using  $K = 1600$  mm/sec.

English

	SG4-14-060	SG4-30-060
T	0.393 sec	0.394 sec
C	0 mm	128 mm
S	641.6 mm	758.4 mm



**WARNING:** The reference standard is EN 999 "Machine safety - the positioning of the protective device based on the approaching speed of the human body".

The following information is to be considered as indicative and concise. For correct safety distance please refer to complete standard EN-999.

### 1.4. Typical applications

The SG4-B FINGER safety light curtains provide solutions in all automation fields where the access to dangerous areas has to be controlled.

In particular, the safety curtains can be used in stopping moving parts in:

- Automatic machines;
- Packaging and cutting machines;
- Textile, wood-working and ceramic machines;
- Automatic assembling lines;
- Milling, lathe and shearing machines;
- Bending and metal-working machines."

**Example 1: Operating point protection on drilling machines**

The operator positions the part and takes it back after machining.

The operator must be protected against possible abrasions while working.

Solution: **SG4-B 14 mm** safety light curtain is especially suitable for this kind of application, which requires the installation of the device directly on the machine.

Benefits: The extremely reduced profile

guarantees installation flexibility adapting itself to the machine dimensions.

The rotating fixing brackets, supplied as accessories, speed up and facilitate mounting.

**Example 2: Bending presses**

The safety device must protect the operator from being squashed between the top and bottom parts or the machined part during the fast approach phase.

Solution: If only one beam of the **SG4-B 14 mm** safety light curtain is interrupted while the press is moving down, the mobile tool bar will stop.

Benefits: The safety light curtain can be used in most bending operations thanks to its easy installation and compact dimensions. As well as offering excellent reliability, **SG4-B 14 mm** ensures increased plant productivity as it reduces the dead times necessary for machine accessing, adjustment and maintenance.



**Example 3 : Paper cutting machines**

These machines typically cut paper to a specific size for newspapers or special applications. The operator must be protected against abrasion or cuts by cutter blades.

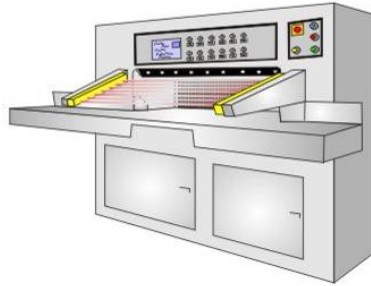

**Solution:** **SG4-B 30 mm** safety light curtain is especially suitable for this kind of application, which require the installation of the device directly on the machine.

**Benefits:** Highly reduced profile and the two side slots ensure installation flexibility for machine dimensions.

**Advantages:** The extremely reduced profile guarantees installation flexibility adapting itself to the machine dimensions.

The rotating fixing brackets, supplied as accessories, speed up and facilitate mounting.

English

**Example 4 : Milling machines**

A milling machine is a machine tool used for the shaping of metals and other solid materials. Operator hands and body must be protected from being dragged, entangled or cut by the tool / spindle.

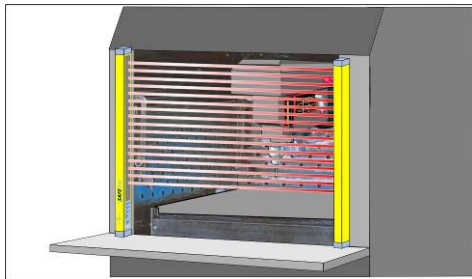

**Solution:** **SG4-B 30 mm**

series safety light curtain is the best solution considering the required safety levels and application type. When even just one of the light curtain beams is interrupted, the machine is immediately stopped.

**Benefits:** The extremely reduced profile guarantees installation flexibility adapting itself to the machine dimensions.

The rotating fixing brackets, supplied as accessories, speed up and facilitate mounting.

## 1.5. Safety information



For a correct and safe use of the safety light curtains of the SG4 series, the following points must be observed:

- The stopping system of the machine must be electrically controlled.
- This control system must be able to stop the dangerous movement of the machine within the total machine stopping time  $T$  as per paragraph 1.3.3, and during all working cycle phases.
- Mounting and connection of the safety light curtain must be carried out by qualified personnel only, according to the indications included in the special sections (refer to sections 2; 3; 4; 5) and in the applicable standards.
- The safety light curtain must be securely placed in a particular position so that access to the dangerous zone is not possible without the interruption of the beams (refer section 2 "Installation mode").
- The personnel operating in the dangerous area must be well trained and must have adequate knowledge of all the operating procedures of the safety light curtain.
- The TEST button must be located outside the protected area because the operator must check the protected area during all Test operation.
- The RESET/RESTART button must be located outside the protected area because the operator must check the protected area during all Reset/Restart operations.

Please carefully read the instructions for the correct functioning before powering the light curtain.

## 2. INSTALLATION MODE

### 2.1. Precautions to be observed for the choice and installation



Make sure that the protection level assured by the SG4 device (Type 4) is compatible with the real danger level of the machine to be controlled, according to **EN 954-1** and **EN 13849-1**.

English

- The outputs (OSSD) of the ESPE must be used as machine stopping devices and not as command devices. The machine must have its own START command.
- The dimension of the smallest object to be detected must be larger than the resolution level of the device.
- The ESPE must be installed in a room complying with the technical characteristics indicated in section 10 “Technical Data”.
- Do not install device near strong and/or flashing light sources or close to similar devices.
- The presence of intense electromagnetic disturbances could jeopardise device functioning. This condition shall be carefully assessed by seeking the advice of DATASENSOR Technical service.
- The operating distance of the device can be reduced in presence of smog, fog or airborne dust.
- A sudden change in environment temperature, with very low minimum peaks, can generate a small condensation layer on the lenses and so jeopardise functioning.

## 2.2. General information on device positioning

The safety light curtain should be carefully positioned, in order to reach a very high protection standard. Access to the dangerous area must only be possible by passing through the protecting safety light beams.



Fig.5a shows some examples of possible access to the machine from the top and the bottom sides. These situations may be very dangerous and so the installation of the safety light curtain at sufficient height in order to completely cover the access to the dangerous area (Fig.5b) becomes necessary.

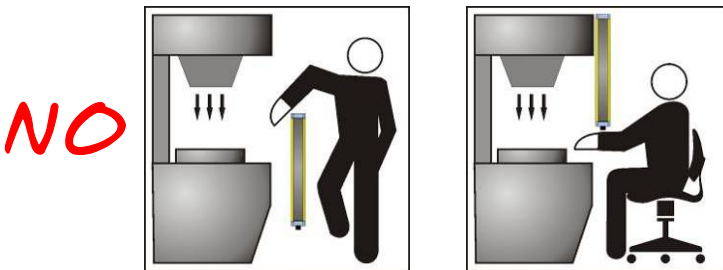

Fig. 5a

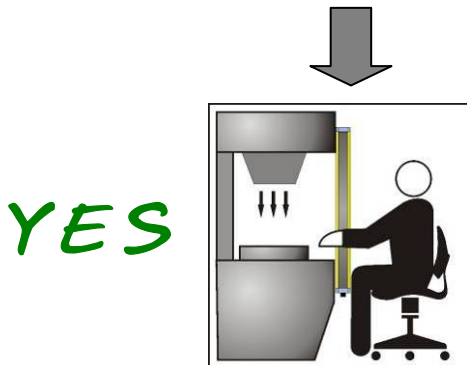

Fig. 5b

Under standard operating conditions, machine starting must not be possible while operators are inside the dangerous area.

When the installation of the safety light curtain near to the dangerous area is not possible, a second light curtain must be mounted in a horizontal position in order to prevent any lateral access, as shown in Fig.6b.



If the operator is able to enter the dangerous area, an additional mechanical protection must be mounted to prevent the access.

NO



Fig. 6a



YES

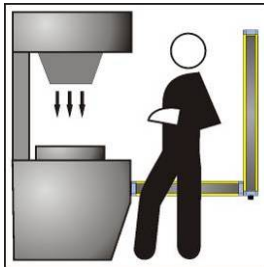

Fig. 6b

English

### 2.2.1. Minimum installation distance

Refer to paragraph 1.3.3. "Minimum installation distance"

### 2.2.2. Minimum distance from reflecting surfaces

Reflecting surfaces placed near the light beams of the safety device (over, under or laterally) can cause passive reflections. These reflections can affect the recognition of an object inside the controlled area.

However, if the RX receiver detects a secondary beam (reflected by the side-reflecting surface) the object might not be detected, even if the object interrupts the main beam.

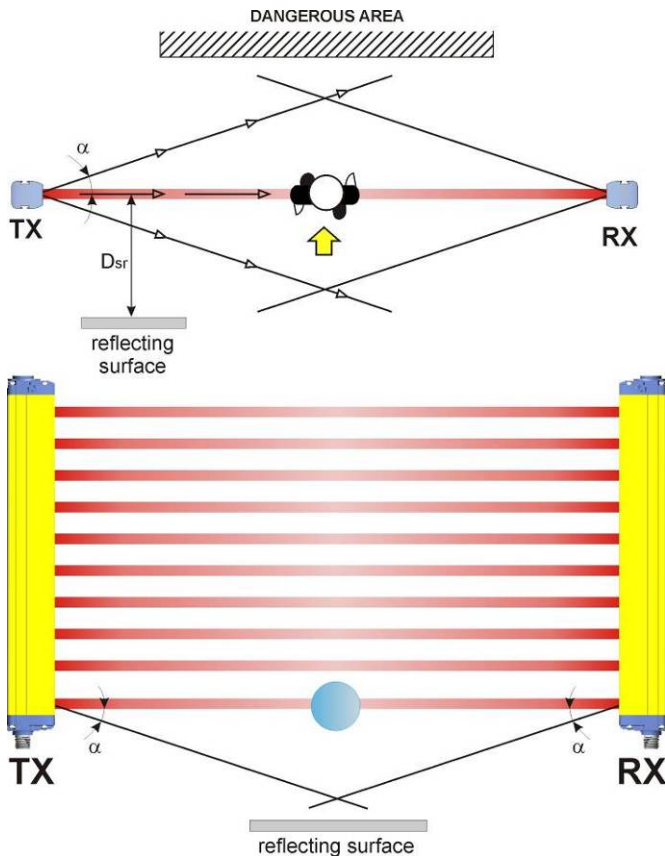

Fig. 7

It is thus important to position the safety light curtain according to the minimum distance from reflecting surfaces.

The minimum distance depends on:

- operating distance between emitter (TX) and receiver (RX);
- real aperture angle of ESPE (EAA); especially:

**for ESPE type 4 EAA = 5° ( $\alpha = \pm 2,5^\circ$ )**

Diagram of Fig. 8 shows the minimum distance from the reflecting surface ( $D_{sr}$ ), based on the operating distance:

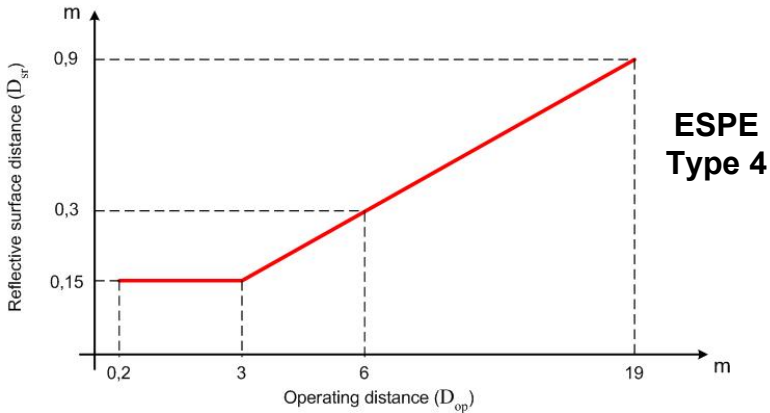

**Fig. 8**

The formula to get  $D_{sr}$  is the following:

$$D_{sr} (m) = 0.15$$

for oper.distance < di 3 m

$$D_{sr} (m) = 0.5 \times \text{operating distance (m)} \times \text{tg } 2\alpha$$

for oper.distance  $\geq$  di 3 m

2.2.3. Distance between homologous devices

If different safety devices have to be installed in adjacent areas, the emitter of one device must not interfere dangerously with the receiver of the other device.

The TX<sub>B</sub> interfering device must be positioned outside a minimum D<sub>do</sub> distance from the TX<sub>A</sub> – RX<sub>A</sub> emitter-receiver couple axis.

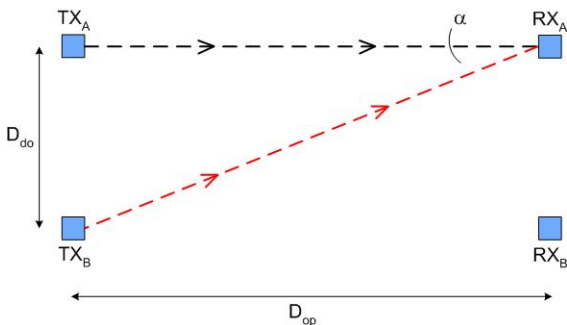

This minimum D<sub>do</sub> distance depends on:

- the operating distance between emitter (TX<sub>A</sub>) and receiver (RX<sub>A</sub>)
- the effective aperture angle of the ESPE (EAA)

The following graphic shows the distance from the interfering devices (D<sub>do</sub>) according to the operating distance (D<sub>op</sub>) of the couple ( TX<sub>A</sub> – RX<sub>A</sub> ).

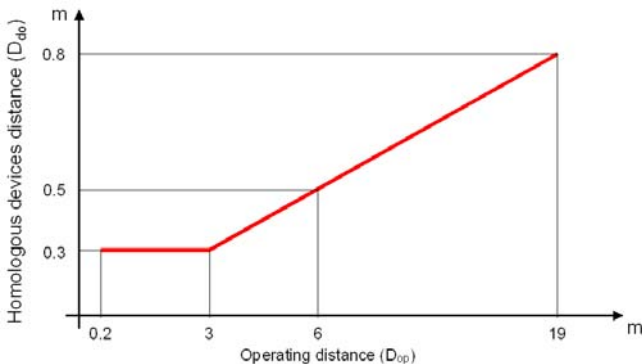

The following table shows, for convenience, the values of the minimum installation distances relative to some operating distances:

Operating distance (m)	Minimum installation distance (m)
3	0,3
6	0,4
10	0,5
19	0,6

**WARNING:** the interfering device ( $TX_B$ ) must be positioned at the same Ddo distance, calculated as shown above, even if closer to  $TX_A$  respect to  $RX_A$ .

English

Installation precautions have to be taken to avoid interference between homologous devices. A typical situation is represented by the installation areas of several adjacent safety devices aligned one next to the other, for example in plants with different machines.

Fig.9 provides two examples:

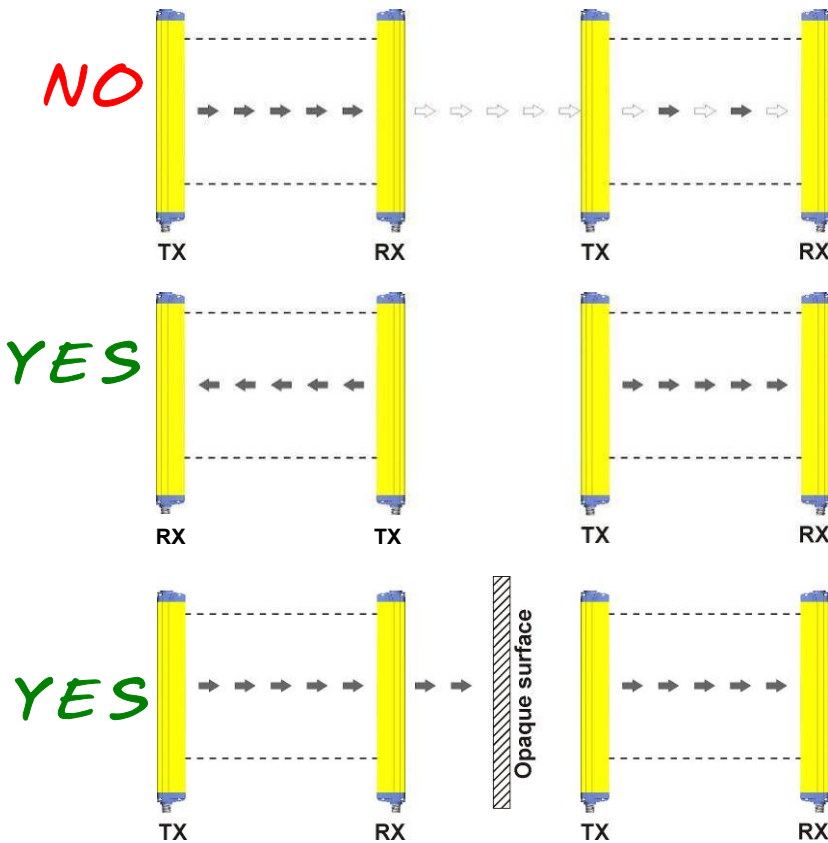

Fig. 9

### 2.2.4. Emitter and receiver orientation

The two units shall be assembled parallel each other, with the beams arranged at right angles with the emission and receiving surface, and with the connectors orientated towards the same direction.

The configurations shown in Fig.10 must be avoided:

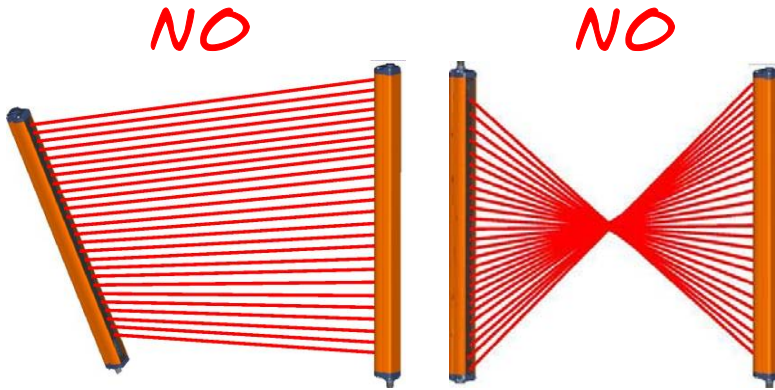

Fig. 10

English

### 2.2.5. Use of deviating mirrors

The control of any dangerous area, with several but adjacent access sides, is possible using only one safety device and well-positioned deviating mirrors.

Fig.11 shows a possible solution to control three different access sides, using two mirrors placed at 45° respect to the beams.

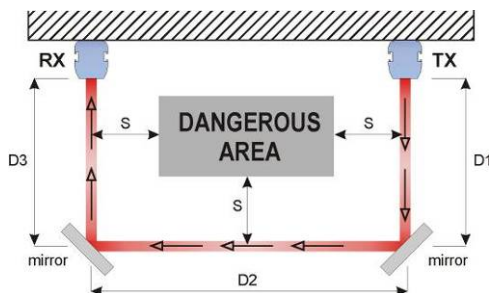

Fig. 11

The operator must respect the following precautions when using the deviating mirrors:

- The alignment of the emitter and the receiver can be a very critical operation when deviating mirrors are used. Even very small displacements of the mirror is enough to lose alignment. The use of Datasensor laser pointer accessory is recommended under these conditions.
- The minimum safety distance (S) must be respected for each single section of the beams.
- The effective operating range decreases by about 15% by using only one deviating mirror, the percentage further decreases by using 2 or more mirrors (for more details refer to the technical specifications of the mirrors used).

The following table shows the operating distances relating to the number of mirrors used.

Number of mirrors	Operating distance (14 mm)	Operating distance (30 mm)
1	5.1 m	16.5 m
2	4.3 m	13.7 m
3	3.7 m	11.6 m

- Do not use more than three mirrors for each device.
- The presence of dust or dirt on the reflecting surface of the mirror causes a drastic reduction in the range.

### 2.2.6. Controls after first installation

The control operations to carry-out after the first installation and before machine start-up are listed hereinafter. The controls must be carried-out by qualified personnel, either directly or under the strict supervision of the person in charge of machinery Safety.

Verify that:

ESPE remains blocked () intercepting the beams along the protected area using the specific test piece, following the Fig.12 scheme.

**TP14 for light curtains with 14 mm resolution: SG4-14-XX-X**

**TP30 for light curtains with 30 mm resolution: SG4-30-XX-X**

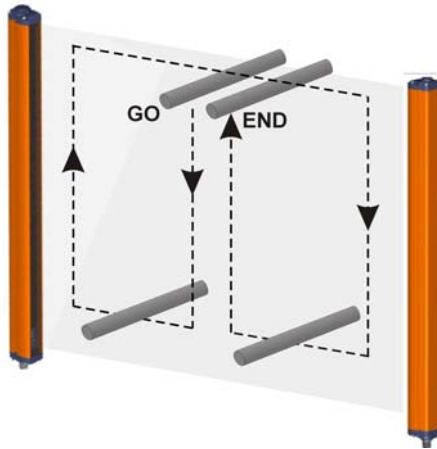

Fig. 12

- ESPE has to be correctly aligned, press slightly on the product side in both directions the red LED must not turn on ➡️.
- The activation of the TEST function causes the opening of the OSSD outputs (red LED ➡️ on and controlled machine stop).
- The response time at machine STOP, including the ESPE and machine response times, must be included in the limits defined in the calculation of the safety distance (refer to section 2 “Installation modes”).
- The safety distance between the dangerous parts and ESPE must comply with the requirements indicated in section 2 “Installation modes”.
- A person must not access or remain between ESPE and the dangerous parts of the machine.
- Access to the dangerous areas of the machine must not be possible from any unprotected area.
- ESPE must not be disturbed by external light sources, ensuring that it remains in Normal operating function for at least 10-15 minutes and placing the specific test piece in the protected area in the SAFE condition for the same period.
- Verify the correspondence of all the accessory functions, activating them in the different operating conditions.

### 3. MECHANICAL MOUNTING

The emitting (TX) and receiving (RX) units must be installed with the relevant sensitive surfaces facing each other. The connectors must be positioned on the same side and the distance must be included within the operating range of the model used (see section 10 “Technical data”).

The two units must be positioned the most aligned and parallel possible.

The next step is the fine alignment, as shown in section 5 “Alignment Procedure”.

Two types of brackets can be used to fix the two units:

#### **Angled fixing brackets**

Angled fixing brackets are supplied with all SG4-B models (Fig.13). Adjustable supports for correcting unit inclination on the axes are available on request (see section 14 “Accessories”).

For fixing with angled brackets, refer to Fig.13.

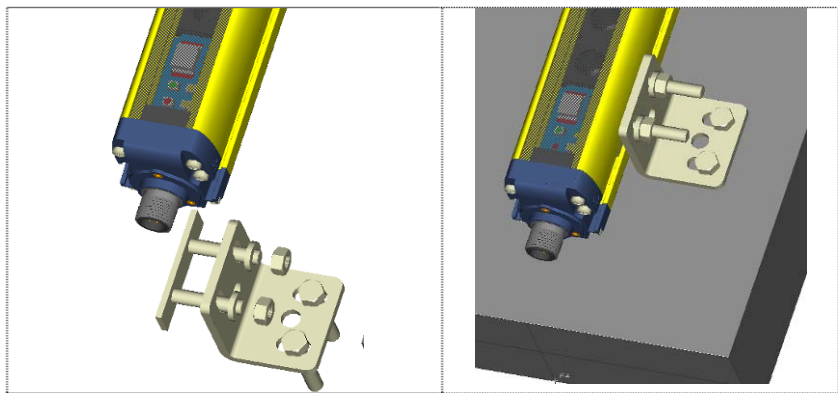
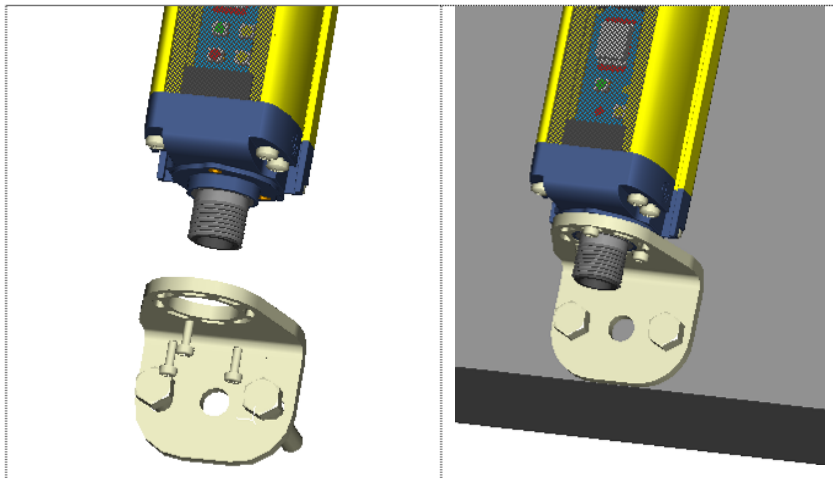

**Fig. 13**

### **Rotating brackets**

Rotating brackets (Fig.14), available upon request, can be used as an alternative or together with angled brackets.

For fixing with rotating bracket, refer to Fig.14.



**Fig. 14**

In case of applications with particularly strong vibrations, vibration dampers together with mounting brackets are recommended to reduce the impact of the vibrations.

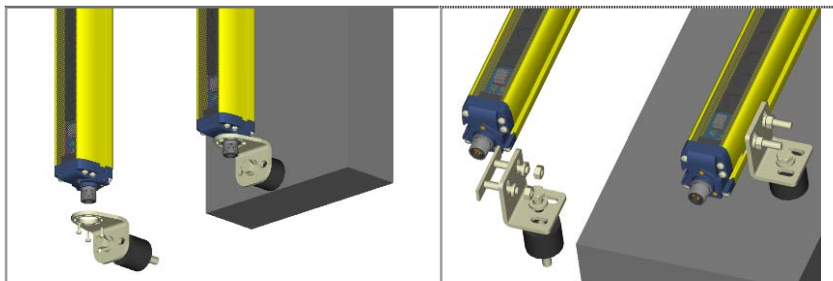

**Fig. 15**

The recommended mounting positions according to the light curtain length are shown in Fig.15 and in the following table.

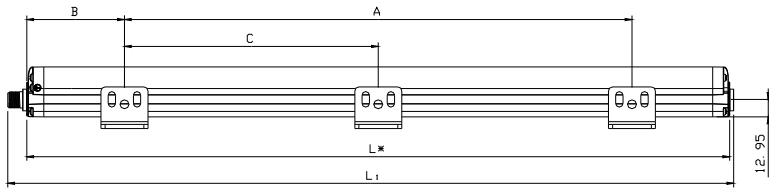

MODEL	L (mm)	A (mm)	B (mm)	C (mm)
SG4-xx-015-00-E	216.3	108	54	-
SG4-xx-030-00-E	366.2	216	75	-
SG4-xx-045-00-E	516.3	316	100	-
SG4-xx-060-00-E	666.2	366	150	-
SG4-xx-075-00-E	816.3	466	175	-
SG4-xx-090-00-E	966.2	566	200	-
SG4-xx-105-00-E	1116.2	666	225	-
SG4-xx-120-00-E	1266.3	966	150	483
SG4-xx-135-00-E	1416.2	1066	175	533
SG4-xx-150-00-E	1566.3	1166	200	583
SG4-xx-165-00-E	1716.3	1266	225	633
SG4-xx-180-00-E	1866.3	1366	250	683

xx = Resolution (14 mm – 30 mm)

## 4. ELECTRICAL CONNECTIONS

All electrical connections to the emitting and receiving units are made through a male M12 connector, located on the lower part of the two units. For receiver a M12 8-pole connector is used, while for emitter a M12 4-pole connector is used.

### RECEIVER (RX):

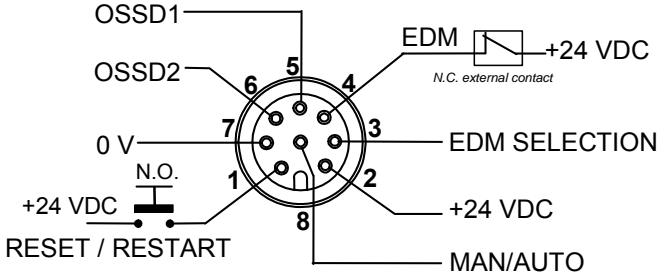

- |   |          |                              |
|---|----------|------------------------------|
| 1 | = white  | = RESET / RESTART(*)         |
| 2 | = brown  | = +24 VDC                    |
| 3 | = green  | = EDM SELECTION              |
| 4 | = yellow | = EDM                        |
| 5 | = grey   | = OSSD 1                     |
| 6 | = pink   | = OSSD 2                     |
| 7 | = blue   | = 0 V                        |
| 8 | = red    | = MANUAL / AUTOMATIC RESTART |

- (\*) automatic RESTART → RESET function  
 manual RESTART → RESET / RESTART function

### EMITTER (TX):

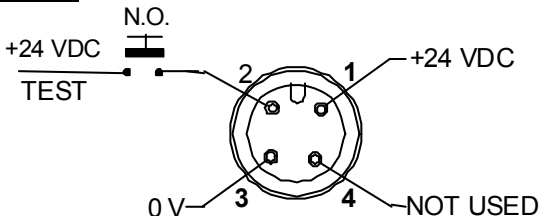

- |   |         |            |
|---|---------|------------|
| 1 | = brown | = +24 VDC  |
| 2 | = white | = TEST     |
| 3 | = blue  | = 0 V      |
| 4 | = black | = NOT USED |

Function	Connection to	Status
TEST	+ 24 VDC	TEST ON
	Not connected or 0V	TEST OFF
RESET	+ 24 VDC	RESET ON
	Not connected or 0V	RESET OFF
EDM	Normally closed contact for a force- guided relay	EDM is active
	Not connected or 0V	EDM is not active
EDM SELECTION	+ 24 VDC	EDM OFF
	Not connected or 0V	EDM ON
MAN/AUTO RESTART	OSSD1	AUTOMATIC RESTART
	OSSD2	MANUAL RESTART

#### 4.1. Notes on connections

For the correct functioning of the SG4 safety light curtains, the following precautions regarding the electrical connections have to be respected:

- Do not place connection cables in contact with or near high-voltage cables and/or cable undergoing high current variations (e.g. motor power supplies, inverters, etc.);

-  • Do not connect in the same multi-pole cable the OSSD wires of different light curtains;

- The TEST wire must be connected through a N.O. button to the supply voltage of the ESPE.

- The RESET/RESTART wire must be connected through a N.O. button to the supply voltage of the ESPE.

 The TEST button must be located in such a way that the operator can check the protected area during any test (see section 6 "*Functioning mode*").

 The RESET/RESTART button must be located in such a way that the operator can check the protected area during any reset operation (see section 6 "*Functioning mode*").

- The device is already equipped with internal overvoltage and overcurrent suppression devices. The use of other external components is not recommended.

Example: connection to the safety relay.

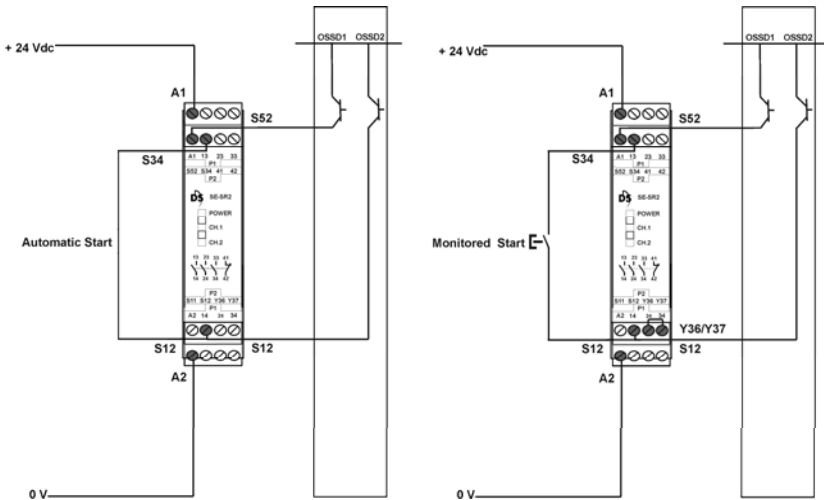



Fig. 16

The figures show the connection between the safety light curtains and the safety relay of the SE-SR2 series functioning in the Automatic Restart mode (left side) and Manual Restart with monitoring (right side).

- 
Do not use varistors, RC circuits or LEDs in parallel at relay inputs or in series at OSSD outputs.
- The OSSD1 and OSSD2 safety contacts cannot be connected in series or in parallel, but can be used separately (Fig.17), conforming to the plant's safety requirements.

If one of these configurations is erroneously used, the device enters into the output failure condition (see section 7 "Diagnostic functions").

- Connect both OSSDs to the activating device. Failure to connect an OSSD to the activating device jeopardises the system safety degree that the light curtain has to control.

YES

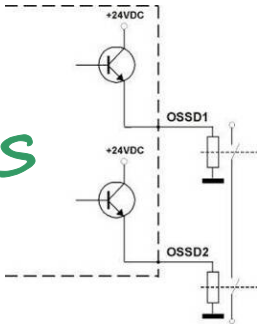

Fig. 17

NO

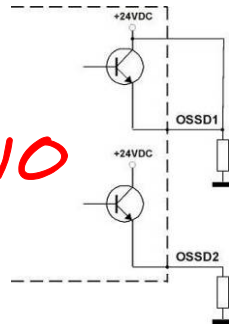

Fig. 18

NO

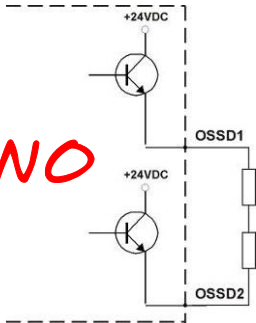

Fig. 19

NO

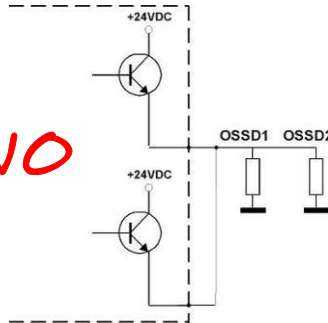
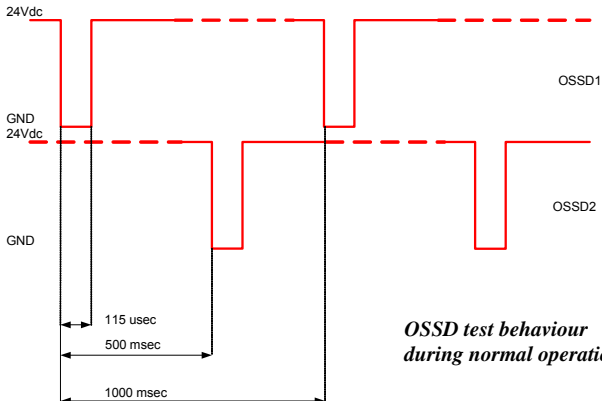

Fig. 20



*OSSD test behaviour during normal operation*

English

## 4.2. Ground connection

SG4 safety light curtain units are preset for easy ground connection. A special compartment, positioned onto caps and marked with the special symbol shown in Figure 21, allows connection with ground cable by means of an additional screw coming with the equipment.

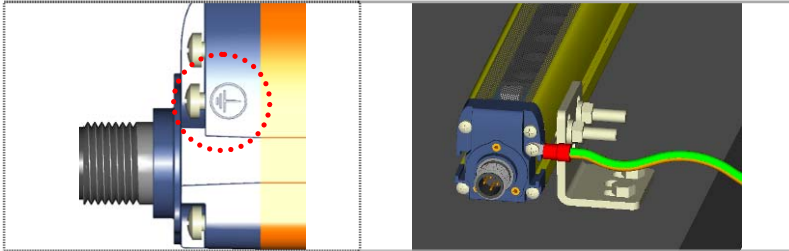

**Fig. 21**

Ground connection configuration is the most common and guarantees the best immunity against electromagnetic disturbances. SG4-B can function even without ground connection. This condition has to be carefully evaluated according to the EMC disturbance immunity and necessary insulation class considering the plant or entire system where the light curtain is installed.

- The ground connection of the two units is not necessary for Class III, while the use of a duly-insulated low-voltage feeder type SELV or PELV is compulsory. In this case, it's mandatory to cover the earth symbol present on the caps of the two units with a blank sticker.
- The ground connection of the two units is compulsory for Class I, while the use of a duly-insulated feeder type SELV or PELV is not compulsory but anyway recommended.

The following table is a summary of SG4 electrical protections.

Electrical protections	Class I	Class III
Ground Connection	Compulsory	Not necessary
Ground connection symbol	Compulsory	Not necessary
Power supply by generators SELV / PELV	Recommended	Compulsory

## 5. ALIGNMENT PROCEDURE

The alignment between the emitting and the receiving units is necessary to obtain the correct functioning of the light curtain. A good alignment prevents outputs instability caused by dust or vibrations.

The alignment is perfect if the optical axes of the first and the last emitting unit's beams coincide with the optical axes of the corresponding elements of the receiving unit.

The beam used to synchronise the two units is the closest one to the connector. SYNC is the optics connected with this beam and LAST is the optics connected to the last beam after the SYNC unit.

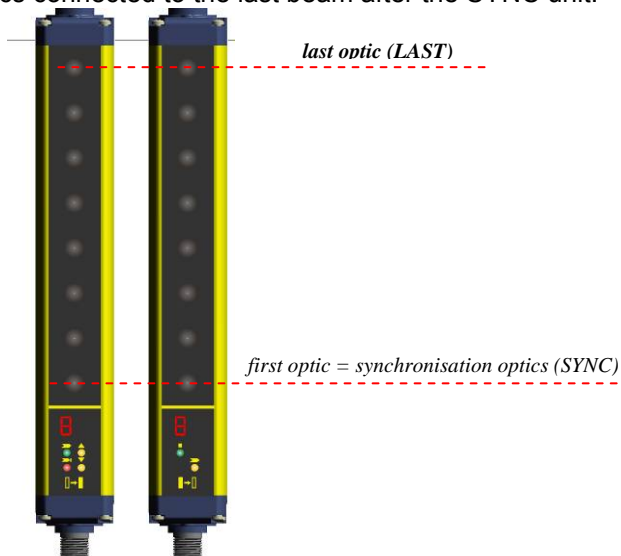

Fig. 22

Signals are clearly identified through symbols allowing their immediate reading, independent of bars directions; a short description of LEDs signals proves nevertheless necessary so as to avoid misunderstandings.

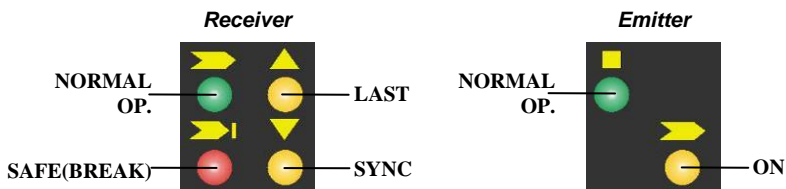









Fig. 22

The standard installation described hereinafter is the one shown in Fig. 22, i.e. with the bar assembled with the connectors pointing down.

### 5.1. Correct alignment procedure

The light curtain alignment can be effected only after having completed the mechanical installation and the electrical connections as described above. Compare alignment results with those given in the following table.

**NOTE:** To enter alignment mode connect the device as described in section 6.5 “Alignment aid function”.

Display	LED NORMAL OP. 	LED SAFE (BREAK) 	LED yellow ▼ SYNC	LED yellow ▲ LAST	Condition	Alignment status
	OFF	ON	ON	ON	Sync NOK Last NOK	Not aligned
			OFF		Sync OK Last NOK	
			OFF	OFF	Sync OK Last NOK Middle optics NOK	
	ON	OFF	OFF	OFF	Each beam is over the min. operating threshold and the number of beam over the threshold is included between 0 and 25%	MINIMUM align.
	ON	OFF	OFF	OFF	Each beam is over the min. operating threshold and the number of beam over the threshold is included between 25 and 50%	
	ON	OFF	OFF	OFF	Each beam is over the min. operating threshold and the number of beam over the threshold is included between 50 and 75%	
	ON	OFF	OFF	OFF	Each beam is over the min. operating threshold and the number of beam over the threshold is included between 75 and 100%	MAXIMUM align.

- A Keep the receiver in a steady position and set the emitter until the yellow LED (▼ SYNC) is OFF. This condition shows the alignment of the first synchronisation beam.
- B Rotate the emitter, pivoting on the lower optics axis, until the yellow LED (▲ LAST) is OFF.

**NOTE:** Ensure that the green LED (➤ NORMAL OP) is steady ON.

- C Delimit the area in which the green LED (➤) is steady through some micro adjustments - for the first and then for the second unit - so to have the maximum alignment (4) and then place both units in the centre of this area.
- D Fix the two units firmly using brackets.
  - Verify that the green LED (➤) on the RX unit is ON and beams are not interrupted, then verify that the red LED SAFE (BREAK) (➤) turns ON if even one single beam is interrupted (condition where an object has been detected).
  - This verification shall be made with the special cylindrical "Test Piece" having a size suitable to the resolution of the device used (refer paragraph 2.2.6 "Controls after first installation").
- E Switch OFF and ON the device in normal operating mode.

The alignment level is monitored also during device standard operating mode via display (see paragraph 7.2).

Once the curtain has been aligned and correctly fastened, the display signal is useful both to check the alignment and show a change in the environmental conditions (occurrence of dust, light disturbance and so on) via signal level monitoring.

## 6. FUNCTIONING MODE

### 6.1. Restart mode

The interruption of a beam due to an opaque object causes the opening of OSSD outputs and the stop of the safety light curtain, SAFE (BREAK) condition ➡ I.

ESPE standard operation can be reset (OSSD safety contact closing = NORMAL OP. condition, ➡) in two different ways:

- Automatic Restart, After activation, ESPE resets to standard operating condition once the object has been removed from the controlled area.
- Manual Restart, After activation, ESPE resets to standard operating condition only once the reset function has been enabled and provided that the object has been removed from the controlled area. This condition, called interlock, is signalled on the display (see paragraph 7.2)



**WARNING:** Carefully assess risk conditions and restart modes.

In applications protecting access to dangerous areas, the automatic restart mode is potentially unsafe if it allows the operator to pass completely beyond the sensitive area. In this case, the manual restart or, for example, the manual restart of the SE-SR2 relay (paragraph 4.1 "Notes on connections") is necessary.

#### Time chart (Manual Restart)

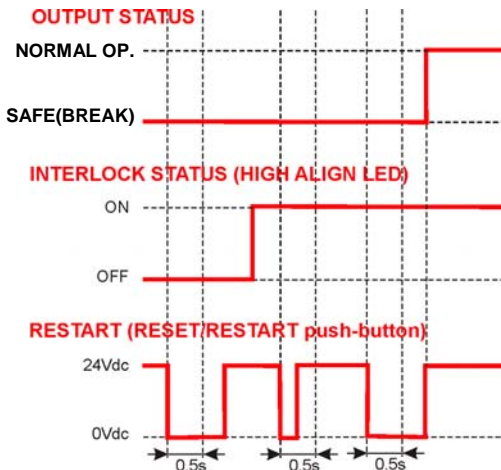

Select either automatic or manual restart by connecting pin of RX connector (see section 4 "Electrical connections")

**6.2. Test function**

The TEST function can be activated by keeping a normally open external contact (TEST push-button), closed for at least 0.5 seconds. The TEST signal is active high.

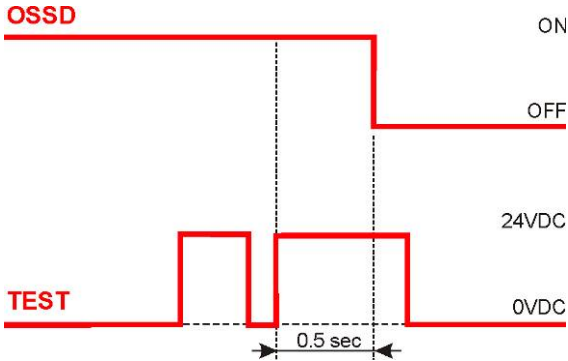

**6.3. Reset function**

The RX light curtain has a RESET function which is activated after an internal error. It can be reset only in case of optical error, OSSD or EDM error or selection of manual/automatic reset (see section 7 "Diagnostic functions").

The RESET function can be activated by keeping a normally open external contact (RESET/RESTART push-button), closed for at least 5 seconds. The RESET signal is active high.

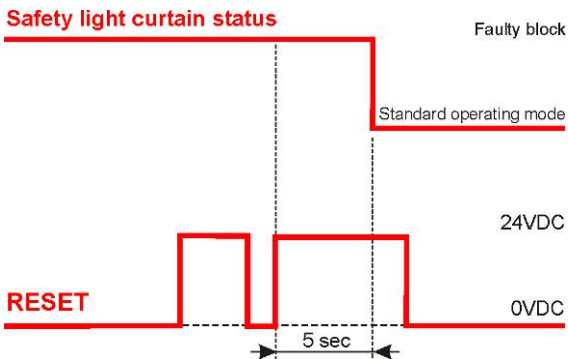

### 6.4. EDM function

The light curtain has a function for monitoring actuation external devices (EDM). This function can be enabled or deactivated.

EDM enabled:

- Disconnect or connect to the ground pin 3 of receiver M12 8-pole connector (EDM enabling = ON).
- Connect EDM input (pin 4 of M12 8-pole – RX) to a 24 VDC normally closed contacts of the device to be monitored.

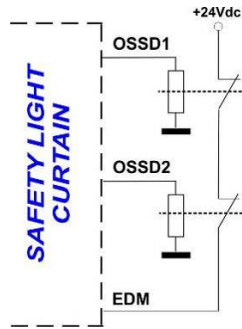

English

**NOTE:** The decimal dot on the display shows that the function is enabled.

EDM deactivated:

- Connect to 24 VDC pin 3 of receiver M12 8-pole connector (EDM enabling = OFF).
- Disconnect or connect to the ground EDM input (pin 4 of M12 8-pole - RX).

This function checks normally closed contact switch on OSSD status change.

**OSSD STATUS**

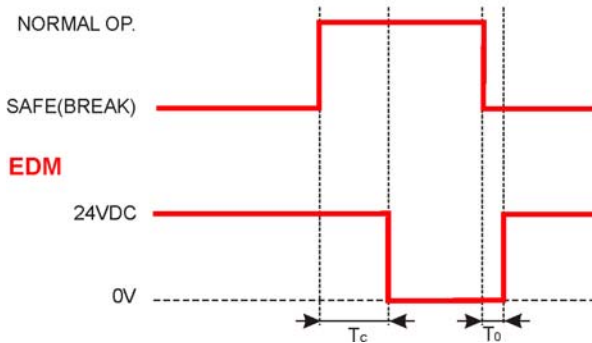

$T_c \geq 350$  msec: 350 msec: time after OSSD OFF-ON switch when EDM test is performed.

$T_o \geq 100$  msec: time after OSSD ON-OFF switch when EDM test is performed.

## 6.5. Alignment aid function

SG4-B light curtain is fitted with a system which informs the user about reached alignment degree. The alignment function can be selected on device starting by keeping closed RESET/RESTART N.O. contact for at least 0.5 seconds (Fig.24).

### **Alignment mode timing**

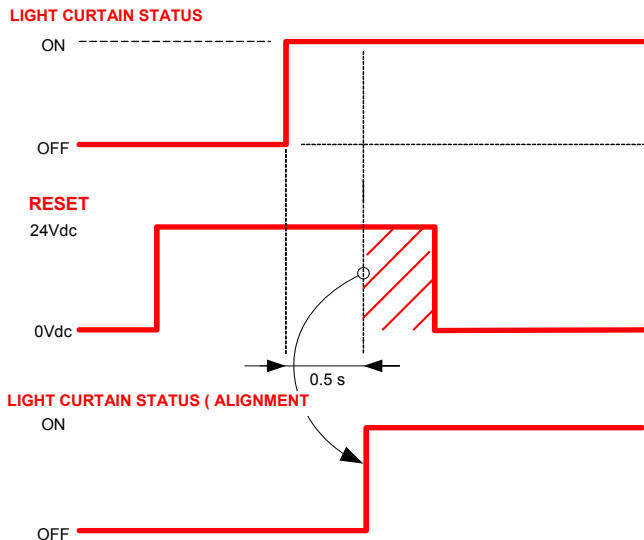

**Fig. 24**

Once optimal alignment has been reached, the device can return to normal functioning by powering off and then powering on the RX unit.

The alignment level is monitored also during device normal operating mode via display (see paragraph 7.2). Once the curtain has been aligned and correctly fastened, the display signal is useful to check the alignment and view any change in the environmental conditions (presence of dust, light disturbance and so on).



**NOTE:** OSSDs are not enabled on alignment mode.

## 7. DIAGNOSTIC FUNCTIONS

### 7.1. User interface

Curtain operating status is visualised through an one-digit display present on both the receiver and emitter units.

SG4-B also has four LEDs on the receiver and two LEDs on the emitter.

Fig.25 shows all LEDs signalling modes: OFF, ON and BLINKING.

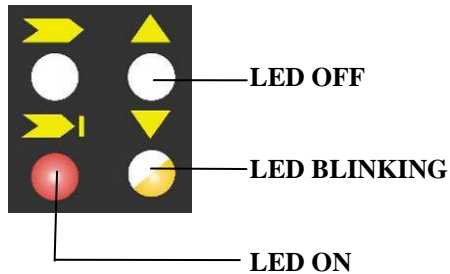













Fig. 25

## 7.2. Diagnostic messages

The operator can evaluate the main causes of the system stop or failure through the display and signalling LEDs.











For Receiver:

Function	Status	Meaning	LED	DIGIT
Normal operation	Alignment	See section 5		
	TEST (red ON)	Light curtain being tested. OSSD status shall be OFF		
	Emission (OSSD ON) (green ON)	Light curtain working in normal operating conditions		
	Interruption (OSSD OFF) (red ON)	Light curtain working in safety block conditions.		
	Interlock Beams free (red ON yellow ON)	Light curtain in interlock, waiting for restart. OSSD status must be OFF		
	Interlock Beams interrupted (red ON yellow ON)	Light curtain in interlock. OSSD status must be OFF		
	Signal level	Minimum (1 bar) Medium (2 bar) Maximum (3 bar)		
	EDM enabled	EDM function is selected		

Function	Type	Check and repair	LED	DIGIT
Error status	OSSD error (red ON)	Check OSSD connections. Make sure that they are not in contact with one another or with the supply cables, then Reset. If the failure continues contact DATASENSOR		
	Internal error (red ON)	Switch OFF and switch ON the power supply circuit. If the failure continues contact DATASENSOR		
	Optical error (red ON)	Reset. If the failure continues contact DATASENSOR		
	EDM error (red ON)	Check EDM connections and lines. If the failure continues contact DATASENSOR		
	Restart selection error (red ON)	Check the man/auto restart connection. If the failure continues contact DATASENSOR		
	No power supply (LEDs OFF)	Check connections and input voltage value. If the failure continues contact DATASENSOR		

English

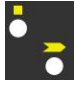
For Emitter:

Function	Status	Meaning	LED	DIGIT
Normal operation	TEST (green ON)	Light curtain being tested. OSSD status on the receiver must be OFF		
	Emission (green ON yellow ON)	Light curtain in normal operating condition		
Function	Type	Check and repair	LED	DIGIT
Error status	Internal error (green ON)	Switch OFF and switch ON the power supply circuit. If the failure continues contact DATASENSOR		
	Optical error (green ON)	Switch OFF and switch ON the power supply circuit. If the failure continues contact DATASENSOR		
	No power supply (LEDs OFF)	Check connections and input voltage correct value. If the failure continues contact DATASENSOR		

## 8. PERIODICAL CHECKS

The following is a list of recommended check and maintenance operations that should be periodically carried-out by qualified personnel (Paragraph 2.2.6 “Controls after first installation”)

Check that:

- The ESPE stays locked (➤|) during beam interruption along the entire protected area, using the suitable “Test Piece” (\*)
- The ESPE is correctly aligned. Press slightly product side, in both directions and the red LED (➤|) must not turn ON.
- Enabling the TEST function, the OSSD outputs should open (the red LED ➤| is ON and the controlled machine stops).
- The response time upon machine STOP (including response time of the ESPE and of the machine) is within the limits defined for the calculation of the safety distance (see section 2 “Installation mode”).
- The safety distance between the dangerous areas and the ESPE are in accordance with the instructions included in section 2 “Installation mode”.
- Access of a person between ESPE and machine dangerous parts is not possible nor is it possible for him/her to stay there.
- Access to the dangerous area of the machine from any unprotected area is not possible.
- The ESPE and the external electrical connections are not damaged.

The frequency of checks depends on the particular application and on the operating conditions of the safety light curtain.

(\*) according to the Fig.12 scheme

Verify that:

ESPE remains blocked (➤|) intercepting the beams along the protected area using the specific test piece, following the Fig.12 scheme.

**TP14 for light curtains with 14 mm resolution: SG4-14-XX-X**  
**TP30 for light curtains with 30 mm resolution: SG4-30-XX-X**

## 8.1. General informatio and useful data

 Safety **MUST** be a part of our conscience.  
The safety devices fulfil their safety function only if they are correctly installed, in accordance with the Standards in force.  
If you are not certain to have the expertise necessary to install the device in the correct way, DATASENSOR Technical Support is at your disposal to carry out the installation.

The device uses fuses that are not self-resetting. Consequently, in presence of short-circuits causing the cut-off of these fuses, both units shall be sent to DATASENSOR Technical Support department.

A power failure caused by interferences may cause the temporary opening of the outputs, but the safe functioning of the light curtain will not be compromised.

## 8.2. Warranty

DATASENSOR S.p.A. guarantees each brand new SG4 system, under standard use conditions, against manufacturing defects in material and workmanship for a period of 36 (thirty-six) months from the date of manufacturing.

DATASENSOR S.p.A. will not be liable for any damages to persons and things caused by failure to stick to the correct installation modes and device use.

Warranty validity is subject to the following conditions:

- User shall notify DATASENSOR S.p.A. the failure within thirty-six months from product manufacturing date.
- Failure or malfunction shall not have been originated directly or indirectly by:
  - use for unsuitable purposes;
  - failure to comply with the intended use prescriptions;
  - negligence, unskillfulness, wrong maintenance;
  - repairing, changes, adaptations not made by DATASENSOR S.p.A personnel, tampering with the device, etc.;
  - accidents or crashes (even due to transportation or by force majeure causes);
  - other causes not depending from DATASENSOR S.p.A.

If the device does not work, send both units (receiver and emitter) to DATASENSOR S.p.A. The Customer is responsible for all transport charges and damage risks or material loss during transport, unless otherwise agreed.

All replaced products and parts become a property of DATASENSOR S.p.A.

DATASENSOR S.p.A. does not accept any warranty or right other than the above-described ones. No requests for compensation for expenses, activities stop or other factors or circumstances somehow connected to the failure of the product or one of its parts to operate cannot be put forward for any reason.

In case of problems, please contact DATASENSOR S.p.A. Service Department:

Tel.: +39 051 6765611

Fax.: +39 051 6759324

email: [service@datasensor.com](mailto:service@datasensor.com)

## 9. DEVICE MAINTENANCE

SG4-B safety light curtains do not require special maintenance operations.

To avoid the reduction of the operating distance, optic protective front surfaces must be cleaned at regular intervals.

Use soft cotton cloths damped in water.

Do not apply too much pressure on the surface in order to avoid making it opaque.

Please do not use on plastic surfaces or on light curtain painted surfaces:

- alcohol or solvents
- wool or synthetic cloths
- paper or other abrasive materials

### 9.1. Product disposal

Under current Italian and European laws, DATASENSOR S.p.A. is not obliged to take care of product disposal at the end of its life.

DATASENSOR S.p.A. recommends to dispose of the product in compliance with local laws or contact authorised waste collection centres.

## 10. TECHNICAL DATA

ELECTRICAL DATA	
Power supply (Vdd):	24 Vdc $\pm$ $\pm$ 20%
Consumption (TX):	2.5 W max
Consumption (RX):	3.5 W max (without load)
Outputs:	2 PNP
Short-circuit protection:	1.4 A max
Output current:	0.5 A max / each output
Output voltage – status ON:	Vdd –1 V min
Output voltage – status OFF:	0.2 V max
Capacitive load	2.2 $\mu$ F @ 24Vdc max
Response times:	See table below
Controlled height:	150..1800 mm
Safety category:	Type 4
Auxiliary functions:	Test; manual/automatic restart; EDM; RESET
Electrical protection:	Class I / Class III (see paragraph 4.2)
Connections:	M12 4-pole for emitter M12 8-pole for receiver
Cable length (for power supply):	50 m. max
OPTICAL DATA	
Light emission ( $\lambda$ ):	Infrared, LED (950 nm)
Resolution:	14 - 30 mm
Operating distance:	0.2...19 m for 30 mm 0.2...6 m for 14 mm
Ambient light rejection:	IEC-61496-2
MECHANICAL AND ENVIRONMENTAL DATA	
Operating temperature:	0...+ 55 °C
Storage temperature:	- 25...+ 70 °C
Temperature class:	T6
Humidity:	15...95 % (no condensation)
Mechanical protection:	IP 65 (EN 60529)
Vibrations:	Width 0.35 mm, Frequency 10 ... 55 Hz 20 sweep per axis, 1 octave/min (EN 60068-2-6)
Shock resistance:	16 ms (10 G) 1,000 shocks per axis (EN 60068-2-29)
Housing material:	Painted aluminium (yellow RAL 1003)
Front glass material:	PMMA
Cap material:	PC MAKROLON
Weight:	1.3 kg / meter for each single unit

## 11. LIST OF AVAILABLE MODELS

Model	Controlled height (mm)	No. Beams	Response time (msec)	Resolution (mm)
SG4-14-015-OO-E	150	16	11	14
SG4-14-030-OO-E	300	32	15	14
SG4-14-045-OO-E	450	48	18	14
SG4-14-060-OO-E	600	64	22	14
SG4-14-075-OO-E	750	80	25	14
SG4-14-090-OO-E	900	96	29	14
SG4-14-105-OO-E	1050	112	33	14
SG4-14-120-OO-E	1200	128	36	14
SG4-14-135-OO-E	1350	144	40	14
SG4-14-150-OO-E	1500	160	43	14
SG4-14-165-OO-E	1650	176	47	14
SG4-14-180-OO-E	1800	192	50	14
SG4-30-015-OO-E	150	8	9	30
SG4-30-030-OO-E	300	16	11	30
SG4-30-045-OO-E	450	24	13	30
SG4-30-060-OO-E	600	32	14	30
SG4-30-075-OO-E	750	40	16	30
SG4-30-090-OO-E	900	48	18	30
SG4-30-105-OO-E	1050	56	19	30
SG4-30-120-OO-E	1200	64	21	30
SG4-30-135-OO-E	1350	72	23	30
SG4-30-150-OO-E	1500	80	25	30
SG4-30-165-OO-E	1650	88	26	30
SG4-30-180-OO-E	1800	96	28	30

## 12. OVERALL DIMENSIONS

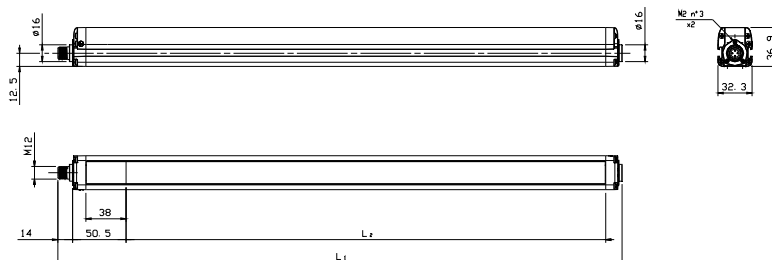

MODEL	$L_1$	$L_2$
SG4-xx-015-OO-E	233.3	153.3
SG4-xx-030-OO-E	383.2	303.2
SG4-xx-045-OO-E	533.2	453.3
SG4-xx-060-OO-E	683.2	603.2
SG4-xx-075-OO-E	833.2	753.3
SG4-xx-090-OO-E	983.2	903.2
SG4-xx-105-OO-E	1133.2	1053.2
SG4-xx-120-OO-E	1283.3	1203.3
SG4-xx-135-OO-E	1433.2	1353.2
SG4-xx-150-OO-E	1583.3	1503.3
SG4-xx-165-OO-E	1733.3	1653.3
SG4-xx-180-OO-E	1883.3	1803.3

xx = Resolution (14 mm – 30 mm)

English

### 13. OUTFIT

#### Angled fixing bracket

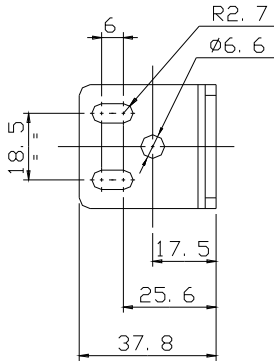
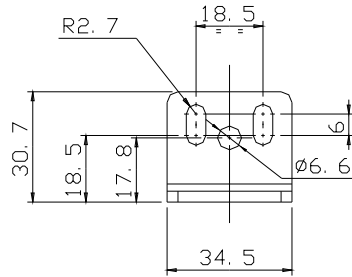
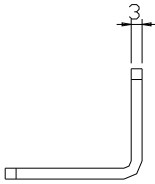

### 13.1 Angled fixing bracket mounting

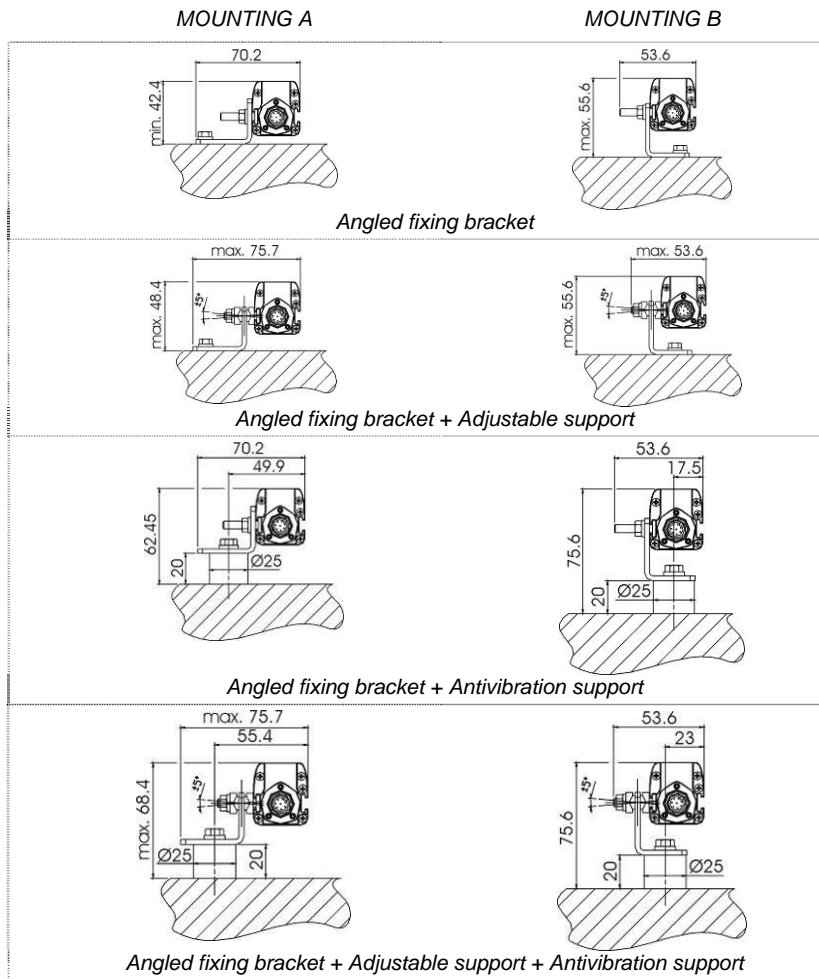

English

MODEL	DESCRIPTION
ST-KSTD	Fixing brackets for angle mounting (4 pc kit)
ST-K4AV	Antivibration support (4 pc kit)
ST-K6AV	Antivibration support (6 pc kit)
ST-K4OR	Orientable supports (4 pc kit)
ST-K6OR	Orientable supports (6 pc kit)

## 14. ACCESSORIES

### Rotating fixing bracket

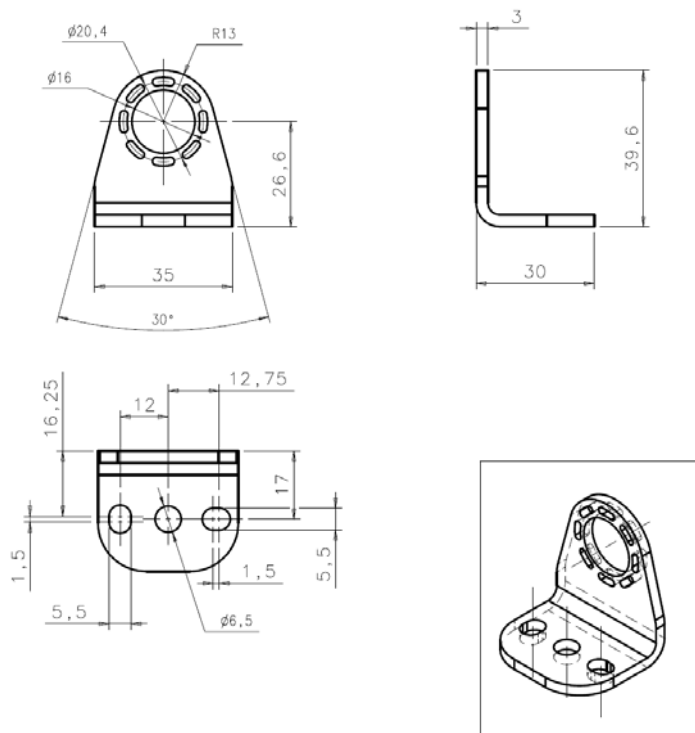

MODEL	DESCRIPTION
-------	-------------

ST-K4ROT	Rotating fixing bracket (4 pc kit)
----------	------------------------------------

## Deviating mirrors

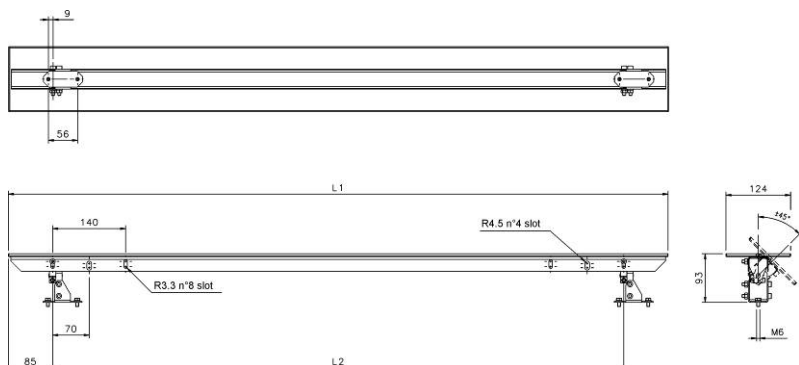

MODEL	DESCRIPTION	L <sub>1</sub> (mm)	L <sub>2</sub> (mm)
SE-DM 500	Deviating mirror H = 550 mm	554	384
SE-DM 600	Deviating mirror H = 700 mm	704	534
SE-DM 800	Deviating mirror H = 900 mm	904	734
SE-DM 900	Deviating mirror H = 1000 mm	1004	834
SE-DM 1200	Deviating mirror H = 1270 mm	1264	1094
SE-DM 1500	Deviating mirror H = 1600 mm	1604	1434

English

Column and floor stands

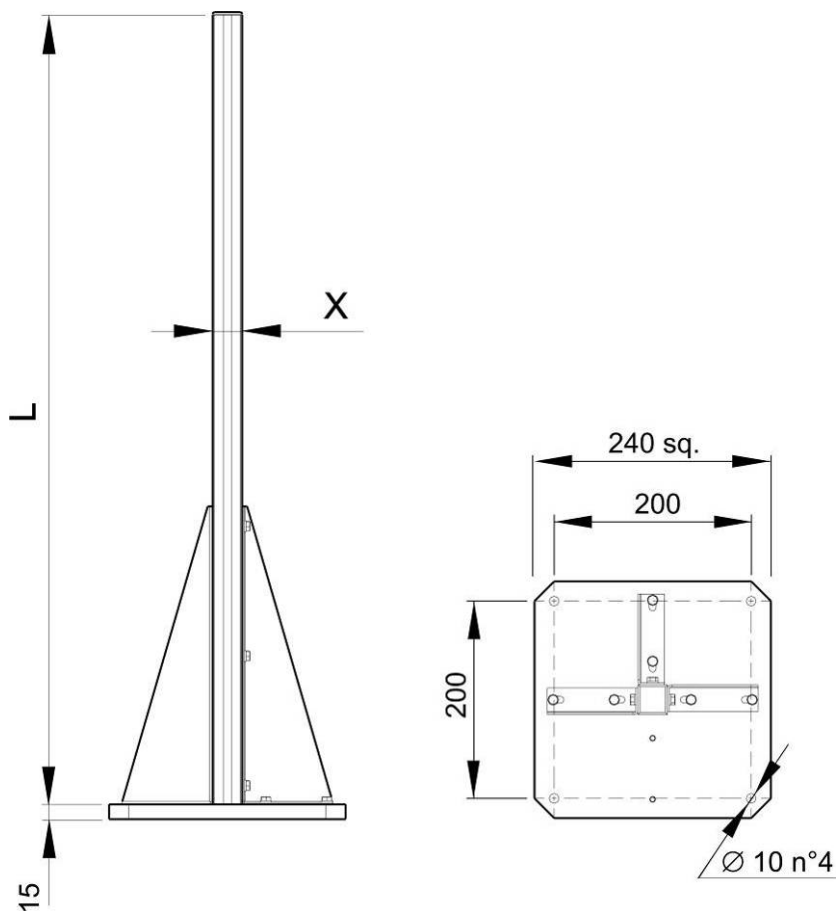

MODEL	DESCRIPTION	L (mm)	X (mm)
SE-S 800	Column and floor stand H= 800 mm	800	30x30
SE-S 1000	Column and floor stand H= 1000 mm	1000	30x30
SE-S 1200	Column and floor stand H= 1200 mm	1200	30x30
SE-S 1500	Column and floor stand H= 1500 mm	1500	45x45
SE-S 1800	Column and floor stand H= 1800 mm	1800	45x45

## Protective stands

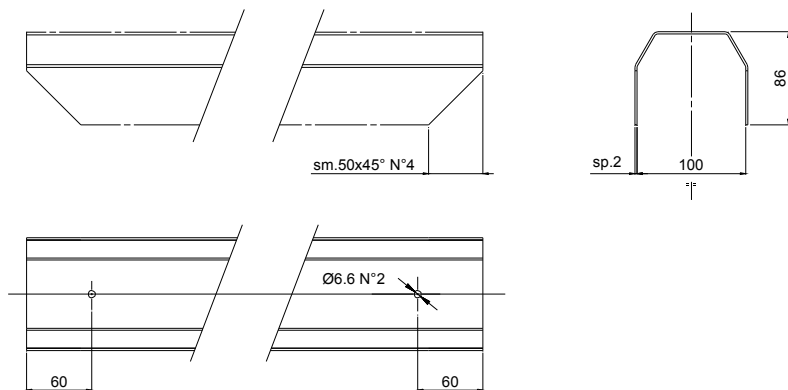

English

MODEL	DESCRIPTION	L (mm)
SE-P 150	Protective stand H= 273 mm	273
SE-P 300	Protective stand H= 420 mm	420
SE-P 450	Protective stand H= 567 mm	567
SE-P 600	Protective stand H = 714 mm	714
SE-P 750	Protective stand H = 861 mm	861
SE-P 800	Protective stand H = 969 mm	969
SE-P 900	Protective stand H = 1069 mm	1069
SE-P 1050	Protective stand H = 1155 mm	1155
SE-P 1200	Protective stand H = 1302 mm	1369
SE-P 1350	Protective stand H = 1449 mm	1449
SE-P 1500	Protective stand H = 1596 mm	1596

## Test Piece

MODEL	DESCRIPTION
TP-30	Test piece Ø 30 mm

## Connection cables

MODEL	DESCRIPTION	
CS-A1-02-U-03	4-pole M12 cable (axial)	3 m
CS-A1-02-U-05	4-pole M12 cable (axial)	5 m
CS-A1-02-U-10	4-pole M12 cable (axial)	10 m
CS-A1-02-U-15	4-pole M12 cable (axial)	15 m
CS-A1-02-U-25	4-pole M12 cable (axial)	25 m
CS-A1-03-U-03	5-pole M12 cable (axial)	3 m
CS-A1-03-U-05	5-pole M12 cable (axial)	5 m
CS-A1-03-U-10	5-pole M12 cable (axial)	10 m
CS-A1-03-U-15	5-pole M12 cable (axial)	15 m
CS-A1-03-U-25	5-pole M12 cable (axial)	25 m
CS-A1-06-U-03	8-pole M12 cable (axial)	3 m
CS-A1-06-U-05	8-pole M12 cable (axial)	5 m
CS-A1-06-U-10	8-pole M12 cable (axial)	10 m
CS-A1-06-U-15	8-pole M12 cable (axial)	15 m
CS-A1-06-U-25	8-pole M12 cable (axial)	25 m

Safety relay

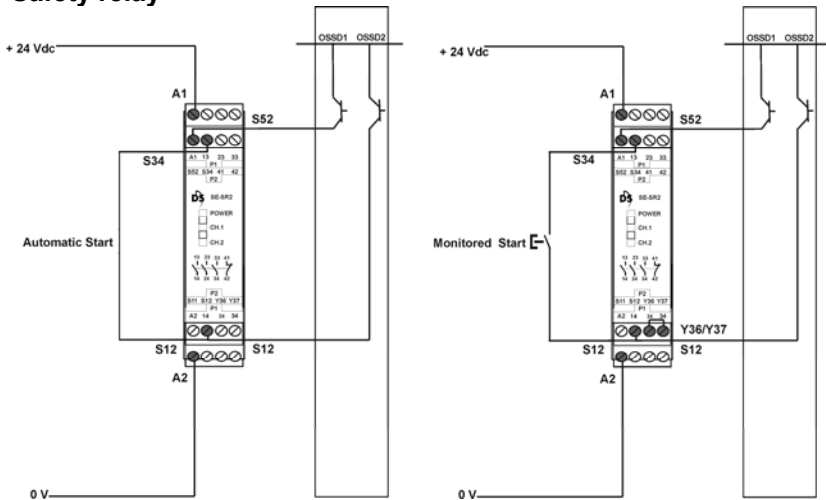

English

The drawing shows the connection between the safety light curtain and the Type 4 safety relay of the SE-SR2 series functioning in the automatic Start mode (left side) and manual Start with monitoring (right side).

MODEL

DESCRIPTION

SE-SR2	Type 4 safety relay - 3 NO 1NC
--------	--------------------------------

## 15. GLOSSARY

**ACTIVE OPTOELECTRONIC PROTECTIVE DEVICE (AOPD):** its detection function is achieved thanks to the use of optoelectronic receivers and emitters detecting the optical beams interruptions inside the device caused by an opaque object present inside the specified detecting area.

An active optoelectronic protective device (AOPD) can operate both in emitter-receiver mode and in retro-reflective light curtains.

**BLOCK CONDITION (=BREAK):** status of the light curtain taking place when a suitably-sized opaque object (see DETECTING CAPACITY) interrupts one or several light curtain beams.

Under these conditions, OSSD1 and OSS2 light curtain outputs are simultaneously switched OFF within the device response time.

**CONTROLLED MACHINE:** machine having the potentially-dangerous points protected by the light curtain or by another safety system.

**CROSSING HAZARD:** situation under which an operator crossing the area controlled by the safety device and this latter stops and keeps the machine stopped until the hazard is eliminated, and then enters the dangerous area. Now the safety device could not be able to prevent or avoid an unexpected restart of the machine with the operator still present inside the dangerous area.

**DANGEROUS AREA:** area representing an immediate or imminent physical hazard for the operator working inside it or who could get in contact with it.

**DETECTING CAPACITY (= RESOLUTION):** sensor function parameter limit as specified by the manufacturer, which activates the electrosensitive protection equipment (ESPE). In case of an active optoelectronic protective device (AOPD), with resolution we mean the minimum dimension, which an opaque object must have in order to interrupt at least one of the beams that constitute the sensitive area.

**EDM:** see "External device monitoring) in the glossary.

**ELECTROSENSITIVE PROTECTIVE EQUIPMENT (ESPE):** assembly of devices and/or components working together to activate the protective disabling function or to detect the presence of something and including at least: a sensor, command/control devices and output signal switching devices.

**EMITTER:** unit emitting infrared beams, consisting of a set of optically-synchronised LEDs. The emitting unit, combined with the receiving unit (installed in the opposite position), generates an optical “curtain”, *i.e.* the detecting area.

**EXTERNAL DEVICE MONITORING (EDM):** device used by the ESPE to monitor the status of the external command devices.

**FINAL SWITCHING DEVICE (FSD):** part of the control system involving machine safety conditions. It breaks the circuit to the machine primary control element (MPCE) when the output signal switching device (OSSD) becomes inactive.

**FORCE-GUIDED CONTACTS:** Contacts can be guided forcibly when they are connected mechanically so that they can switch simultaneously, when the input stage is active.

If one contact of the series remains “hanged”, no other relay contact is able to move.

This function allows the control of the EDM status.

**MACHINE OPERATOR:** qualified person allowed to use the machine.

**MACHINE PRIMARY CONTROL ELEMENT (MPCE):** electrically-powered element having the direct control of machine regular operation so as to be the last element, in order of time, to operate when the machine has to be enabled or blocked.

**MIN. INSTALLATION DISTANCE:** min. distance necessary to allow machine dangerous moving parts to completely stop before the operator can reach the nearest dangerous point. This distance shall be measured from the middle point of the detecting area to the nearest dangerous point. Factors affecting min. installation distance value are machine stop time, total safety system response time and light curtain resolution.

**N.O.:** normally opened

**N.C.:** normally closed

**OFF STATUS:** status when the output circuit is interrupted and does not allow current stream.

**ON STATUS:** status when the output circuit is operational and allows current stream.

**OUTPUT SIGNAL SWITCHING DEVICE (OSSD):** part of the ESPE connected to machine control system. When the sensor is enabled during standard operating conditions, it switches to disabled status.

**PROTECTED AREA:** area where a specified test object is detected by the ESPE.

**PROTECTIVE DEVICE:** device having the function to protect the operator against possible risks of injury due to the contact with machine potentially-dangerous parts.

**QUALIFIED OPERATOR:** a person who holds a professional training certificate or having a wide knowledge and experience and who is acknowledged as qualified to install and/or use the product and to carry out periodical test procedures.

**RECEIVER:** unit receiving infrared beams, consisting of a set of optically-synchronised phototransistors. The receiving unit, combined with the emitting unit (installed in the opposite position), generates an optical "curtain", i.e. the detecting area.

**RESPONSE TIME:** max. time elapsing between the occurrence of the event leading to sensor activation and the reaching of the inactive state by the output signal switching device (OSSD).

**RESTART INTERLOCKING DEVICE (=RESTART):** device preventing machine automatic restart after sensor activation during a dangerous phase of machine operating cycle, after a change of machine operating mode, and after a variation in machine start control devices.

**RISK:** probability of occurrence of an injury and severity of the injury itself.

**SAFETY LIGHT CURTAIN:** it is an active optoelectronic protective device (AOPD) including an integrated system consisting of one or several emitting elements and one or several receiving elements forming a detection area with a detecting capacity specified by the supplier.

**START INTERLOCKING DEVICE (= START):** device preventing machine automatic start if the ESPE is live or the voltage is disabled and enabled once again.

**TEST PIECE:** opaque object having a suitable size and used to test safety light curtain correct operation.

**TYPE (OF ESPE):** the Electrosensitive Protective Equipment (ESPE) have different reactions in case of faults or under different environmental conditions. The classification and definition of the "type" (ex. type 2, type 4, according to IEC 61496-1) defines the minimum requirements needed for ESPE design, manufacturing and testing.

**WORKING POINT:** machine position where the material or semifinished product is worked.