

SAFEasy™ TYPE 4 LIGHT CURTAINS

- *Integrated light curtains for HAND PROTECTION*
- *Versions with 20, 30 and 35 mm resolution*
- *Special slot for device setting*
- *35 x 40 mm compact profile*

SE4-HAND SERIES

The **SAFEasy™** light curtains, according to the IEC 61496-1 e IEC 61496-2 standards, are suitable for hand protection of operators exposed to risks.

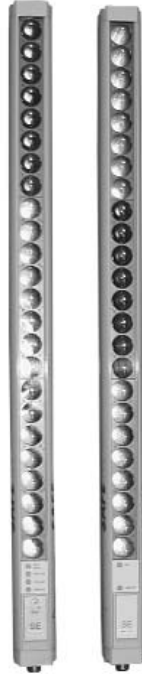

Different models with eleven standard heights ranging from 150 to 1650 mm, with 20, 30 and 35 mm resolutions and operating distance reaching 15 m are available. Specific dip-switches, that can be reached through a slot present on the front of the receiver protected by a lid and opened with a simple screwdriver, guarantee rapid and safe device setting.

The operator is thus able to configure, according to the specific needs, the manual or automatic reset, as well as the muting and partial muting functions.

The emitter-receiver units are optically synchronised and contain all the control circuits, inputs and outputs inside the housing.

A wide range of industrial applications, requiring operator safety, can be solved by the **SAFEasy™** light curtains, thanks to the extremely compact dimensions (35x40 mm) and easy connection and installation.

TECHNICAL DATA

Power supply:	24 Vdc ± 20% (SELV/PELV)
Consumption:	70 mA max. / 2.1 W (emitter) 100 mA max. / 3 W (receiver without load)
Light emission:	infrared LED 880 nm
Number of controlled beams:	<i>refer to table 1</i>
Optic interaxis:	14 mm (SE4-20) 18.4 mm (SE4-30) 18.4 mm (SE4-35)
Resolution:	20 mm (SE4-20) 30 mm (SE4-30) 35 mm (SE4-35)
Controlled height:	<i>refer to table 2</i>
Through beam operating distance:	0.2 ... 6 m (SE4-20) 0.2 ... 15 m (SE4-30) 0.2 ... 15 m (SE4-35)
Receiver inputs:	external switches for Muting, Test, Start and Override
Receiver indicators:	green / red SAFE / BREAK LED 2 yellow ALIGNMENT LEDs green POWER ON LED
Emitter indicators:	yellow blinking FAILURE LED green POWER ON LED
Output type:	2 PNP
Output current:	0.7 A max. 0.25 A max. (45°C - 55°C) short-circuit signalling and protection
Response time:	<i>refer to table 3</i>
Selectable functions:	Total / partial Muting Manual / Automatic reset <i>refer to table 4</i>
Time-out period:	Muting: 10 minutes Override: 2 minutes
Muting signalling lamp:	24 V 3 W min. (125 mA), 7 W max. (300 mA)
Receiver connection:	8-pole M12 connector
Emitter connection:	4-pole M12 connector
Cable length:	50 m max. (with 50 nF capacitive load)
Safety category:	type 4
Electrical protection:	class 1
Mechanical protection:	IP65 IP67 (connector part)
Housing material:	aluminium with PC Makrolon plastic caps
Weight:	1.2 Kg max. / m of total height
Operating temperature:	-10 ... +55 °C
Storage temperature:	-25 ... +70 °C
Reference standards:	EN 954-1, IEC 61496-1, IEC 61496-2
Other functions:	
Certifications:	CE   US LISTED

TABLES

Model	SE4-20	SE4-30/35
SE4 height 150	11	8
SE4 height 300	22	16
SE4 height 450	33	24
SE4 height 600	44	32
SE4 height 750	55	40
SE4 height 900	66	48
SE4 height 1050	77	56
SE4 height 1200	88	64
SE4 height 1350	99	72
SE4 height 1500	110	80
SE4 height 1650	121	88

Table 1: NUMBER OF BEAMS

Model	SE4-20	SE4-30/35
SE4 height 150	161	180
SE4 height 300	308	327
SE4 height 450	455	474
SE4 height 600	602	621
SE4 height 750	749	768
SE4 height 900	896	915
SE4 height 1050	1043	1062
SE4 height 1200	1190	1209
SE4 height 1350	1337	1356
SE4 height 1500	1484	1503
SE4 height 1650	1631	1650

Table 2: CONTROLLED HEIGHT (mm)

Model	SE4-20	SE4-30/35
SE4 height 150	16	15
SE4 height 300	18	17
SE4 height 450	21	18
SE4 height 600	23	20
SE4 height 750	25	22
SE4 height 900	27	23
SE4 height 1050	29	25
SE4 height 1200	32	27
SE4 height 1350	34	28
SE4 height 1500	36	30
SE4 height 1650	39	32

Table 3: RESPONSE TIME (ms)

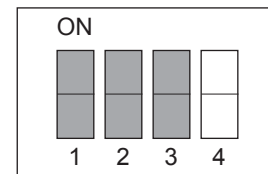

GREY dip-switches: total / partial Muting selection
WHITE dip-switches: manual / auto. reset selection

Table 4: DIP-SWITCH SELECTION

CONNECTIONS

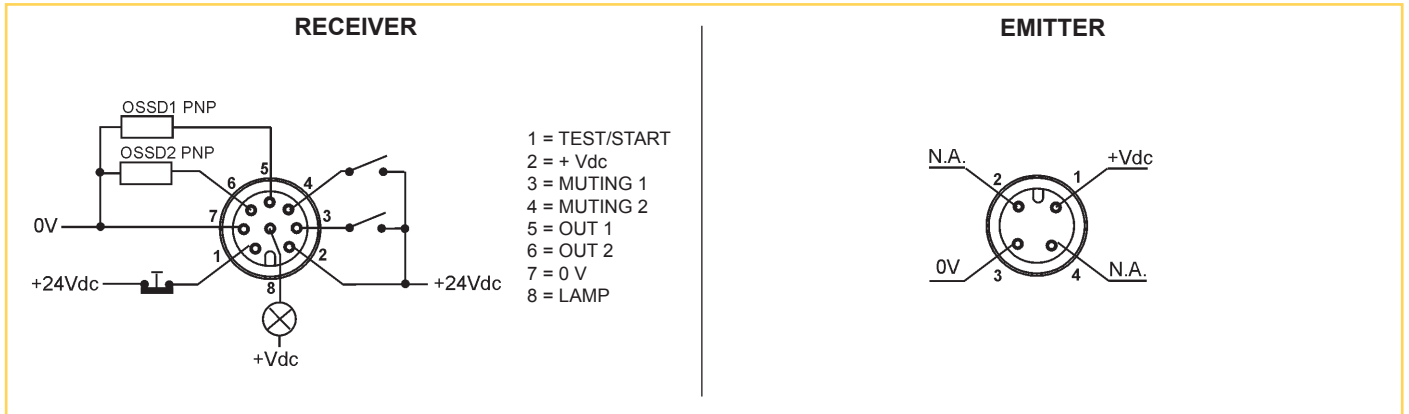

DIMENSIONS

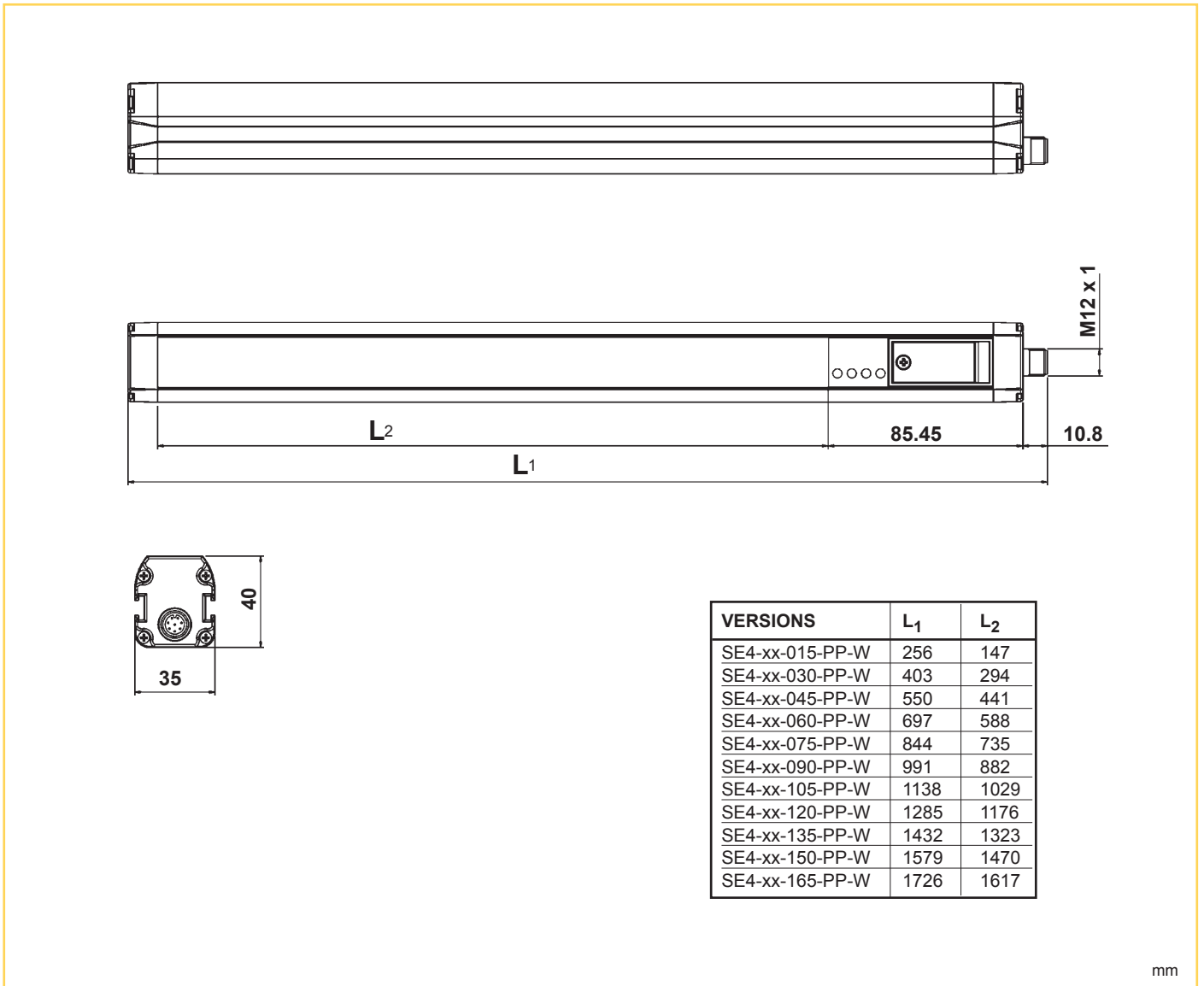

MODELS

MODEL	DESCRIPTION	RESOLUTION	CODE N°
SE4-20-015-PP-W	type 4 safety light curtain, h=150 mm	20 mm	957201270
SE4-20-030-PP-W	type 4 safety light curtain, h=300 mm	20 mm	957201280
SE4-20-045-PP-W	type 4 safety light curtain, h=450 mm	20 mm	957201290
SE4-20-060-PP-W	type 4 safety light curtain, h=600 mm	20 mm	957201250
SE4-20-075-PP-W	type 4 safety light curtain, h=750 mm	20 mm	957201300
SE4-20-090-PP-W	type 4 safety light curtain, h=900 mm	20 mm	957201310
SE4-20-105-PP-W	type 4 safety light curtain, h=1050 mm	20 mm	957201320
SE4-20-120-PP-W	type 4 safety light curtain, h=1200 mm	20 mm	957201330
SE4-20-135-PP-W	type 4 safety light curtain, h=1350 mm	20 mm	957201340
SE4-20-150-PP-W	type 4 safety light curtain, h=1500 mm	20 mm	957201350
SE4-20-165-PP-W	type 4 safety light curtain, h=1650 mm	20 mm	957201360
SE4-30-015-PP-W	type 4 safety light curtain, h=150 mm	30 mm	957201380
SE4-30-030-PP-W	type 4 safety light curtain, h=300 mm	30 mm	957201390
SE4-30-045-PP-W	type 4 safety light curtain, h=450 mm	30 mm	957201400
SE4-30-060-PP-W	type 4 safety light curtain, h=600 mm	30 mm	957201240
SE4-30-075-PP-W	type 4 safety light curtain, h=750 mm	30 mm	957201410
SE4-30-090-PP-W	type 4 safety light curtain, h=900 mm	30 mm	957201420
SE4-30-105-PP-W	type 4 safety light curtain, h=1050 mm	30 mm	957201430
SE4-30-120-PP-W	type 4 safety light curtain, h=1200 mm	30 mm	957201440
SE4-30-135-PP-W	type 4 safety light curtain, h=1350 mm	30 mm	957201450
SE4-30-150-PP-W	type 4 safety light curtain, h=1500 mm	30 mm	957201460
SE4-30-165-PP-W	type 4 safety light curtain, h=1650 mm	30 mm	957201470
SE4-35-015-PP-W	type 4 safety light curtain, h=150 mm	35 mm	957201000
SE4-35-030-PP-W	type 4 safety light curtain, h=300 mm	35 mm	957201010
SE4-35-045-PP-W	type 4 safety light curtain, h=450 mm	35 mm	957201020
SE4-35-060-PP-W	type 4 safety light curtain, h=600 mm	35 mm	957201030
SE4-35-075-PP-W	type 4 safety light curtain, h=750 mm	35 mm	957201040
SE4-35-090-PP-W	type 4 safety light curtain, h=900 mm	35 mm	957201050
SE4-35-105-PP-W	type 4 safety light curtain, h=1050 mm	35 mm	957201060
SE4-35-120-PP-W	type 4 safety light curtain, h=1200 mm	35 mm	957201070
SE4-35-135-PP-W	type 4 safety light curtain, h=1350 mm	35 mm	957201080
SE4-35-150-PP-W	type 4 safety light curtain, h=1500 mm	35 mm	957201090
SE4-35-165-PP-W	type 4 safety light curtain, h=1650 mm	35 mm	957201100

ACCESSORIES

Please refer also to *Safety Device Accessories*

Note: All the accessories have to be ordered separately

Distributed by:

HEADQUARTERS

DATASENSOR SpA

via Lavino, 265 - 40050 Monte San Pietro, BO - Italy
 Tel. +39 051/6765611 • Fax +39 051/6759324
 www.datasensor.com • e-mail info@datasensor.com

Datasensor SpA endeavours to continuously improve and renew its products; for this reason the technical data and contents of this catalogue may undergo variations without prior notice. For correct installation and use Datasensor SpA can guarantee only the data indicated in the instruction manual supplied with the products.